

TTL 6-A

ACTIVE THREE-WAY LINE ARRAY MODULE

DESCRIPTION

The TTL6-A is a high power, three way, active line source engineered to deliver high fidelity output for use indoors and outdoors, for medium to large spaces. TTL6-A provides all the advantages of line array technology, such as high direct sound, increased range and a uniform level distribution, with additional ease of use. It is the preferred sound set-up for stacked systems and when a wider dispersion is required. The 3-way TTL6-A line source is equipped with 2 x 12" low frequencies woofers, 4 x 6.5" midranges and a 3.0" voice coil compression driver with wave-guide for distinctive homogenous directivity. The integration of four channels of digital amplification and the advanced digital processing set a new standard for distortion, noise and thermal efficiency.



FEATURES

- RDNet remote control
- 4 x Class D amplifier, 2200 Watt total power
- Premium-quality DSP with optimized phase response
- 1.4" neo compression driver, 3.0" voice coil with a waveguide
- 4 x 6.0" neo midranges
- 2 x 12" neo woofers
- 139 dB max SPL
- Maximum output, perfect audio fidelity
- Tour grade cabinet and mechanics
- 90°x 30°

TECHNICAL SPECIFICATIONS

Acoustical specifications	Frequency Response:	45 Hz ÷ 20000 Hz
	Max SPL @ 1m:	139 dB
	Horizontal coverage angle:	90°
	Vertical coverage angle:	30°
Transducers	Compression Driver:	1 x 1.4" neo, 3.0" v.c
	Midrange:	4 x 6.0" neo, 2.0" v.c
	Woofer:	2 x 12" neo, 3.0" v.c
Input/Output section	Input signal:	bal/unbal
	Input connectors:	XLR, RDNet Ethercon
	Output connectors:	XLR, RDNet Ethercon
	Input sensitivity:	+4 dBu
Processor section	Crossover Frequencies:	200 Hz - 800 Hz
	Protections:	Thermal, RMS
	Limiter:	Soft Limiter
	Controls:	Close, Linear, Far, 2x Presets
	RDNet:	Yes
Power section	Total Power:	4400 W Peak, 2200 W RMS
	High frequencies:	800 W Peak, 400 W RMS
	Mid frequencies:	1400 W Peak, 700 W RMS
	Low frequencies:	2200 W Peak, 1100 W RMS
	Cooling:	Convection
	Connections:	Powercon IN/OUT
Standard compliance	Safety agency:	CE compliant
Physical specifications	Cabinet/Case Material:	Baltic birch plywood
	Hardware:	Pole Mount, integrated
	Handles:	2 side, 2 back
	Grille:	Steel
	Color:	Black
Size	Height:	1100 mm / 43.31 inches
	Width:	378 mm / 14.88 inches
	Depth:	468 mm / 18.43 inches
	Weight:	53 kg / 116.84 lbs
Shipping information	Package Height:	430 mm / 16.93 inches
	Package Width:	1140 mm / 44.88 inches
	Package Depth:	520 mm / 20.47 inches
	Package Weight:	56 kg / 123.46 lbs



PART NUMBER

- **13000476**

TTL 6-A

100-240V, US

EAN 8024530013592

- **13000475**

TTL 6-A

100-240V, EU

EAN 8024530013608

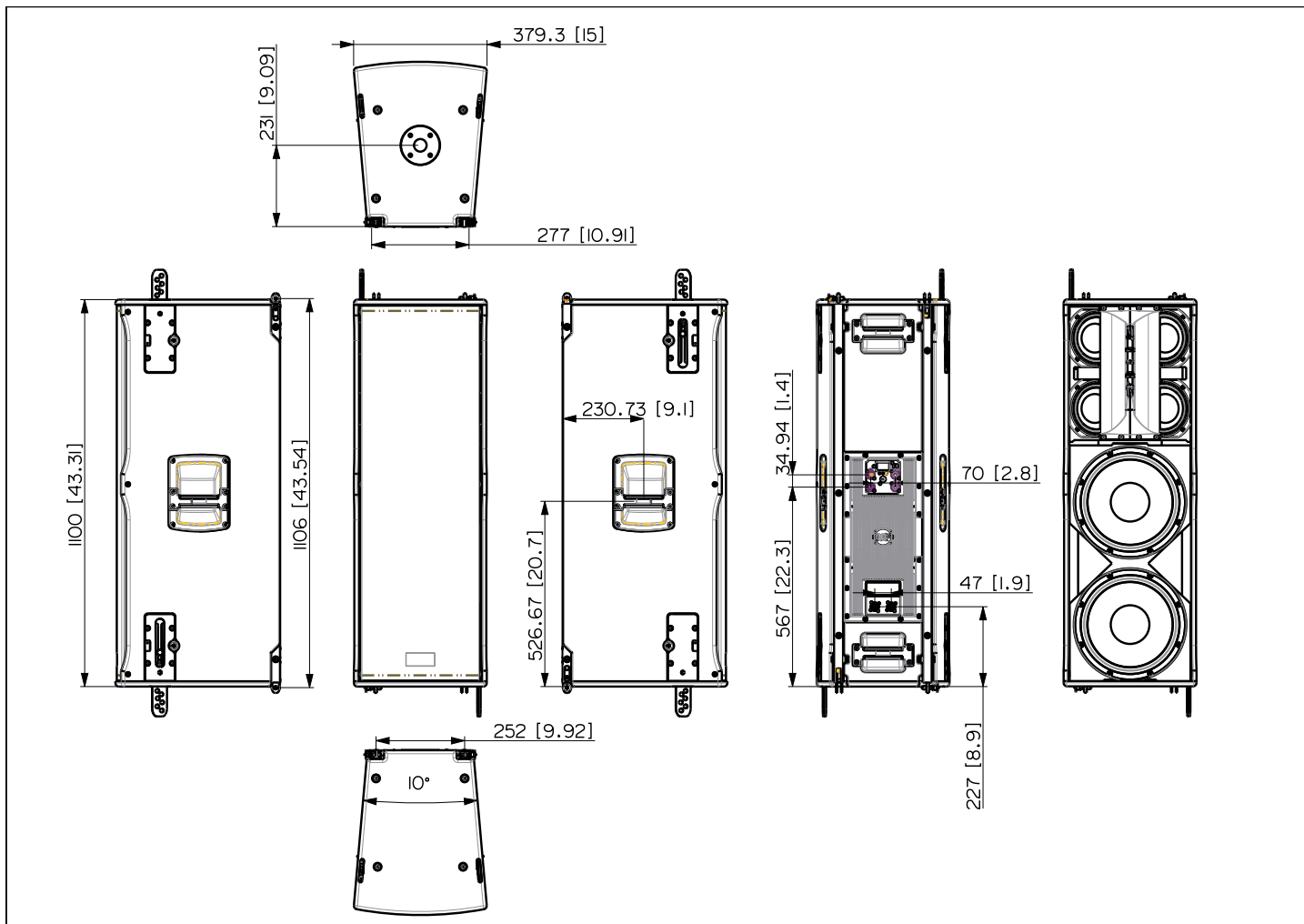

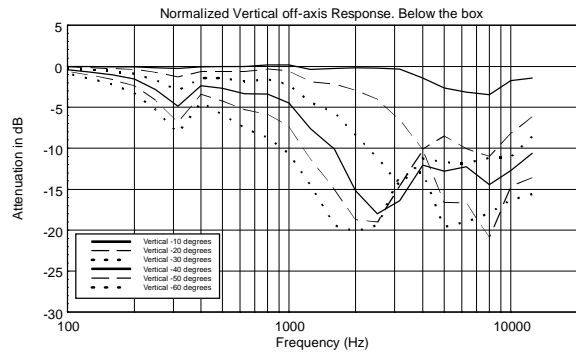
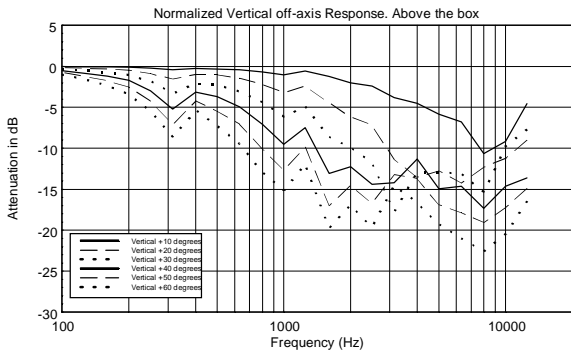
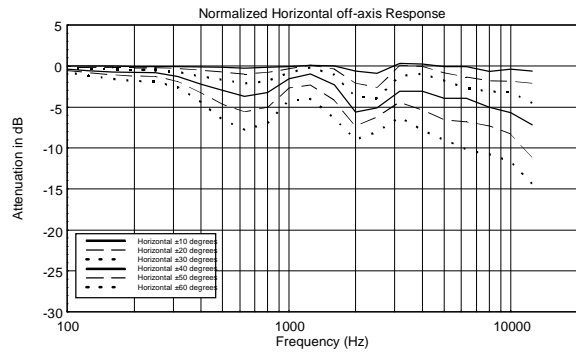
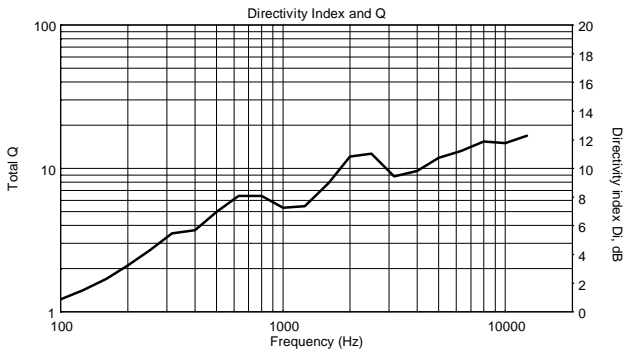
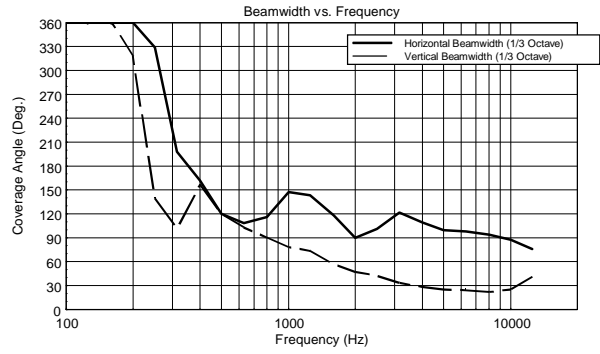
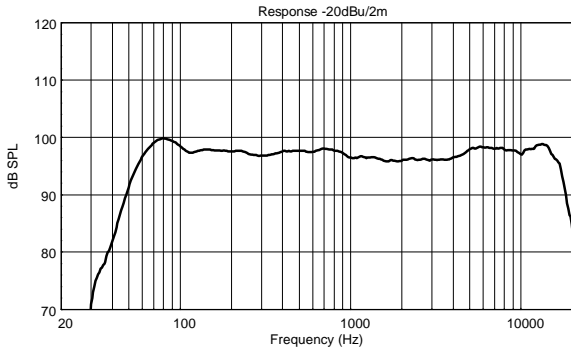

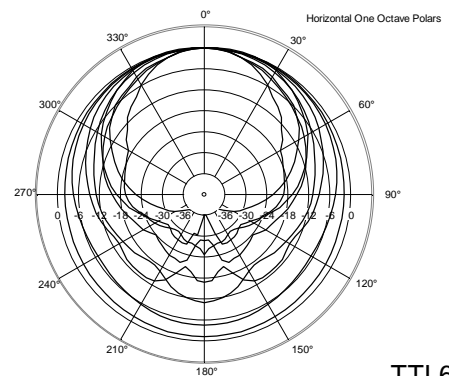
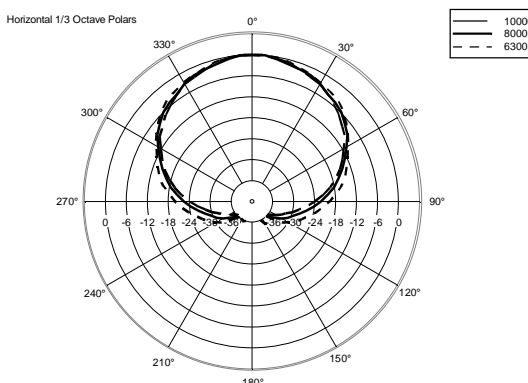
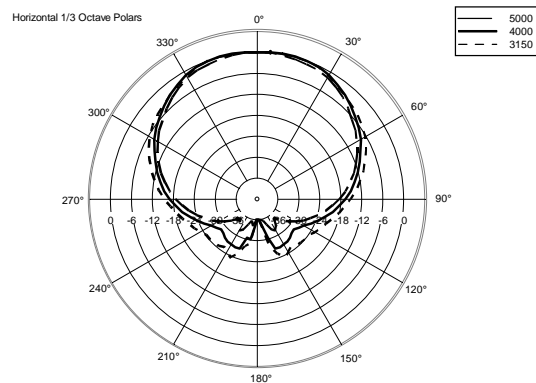
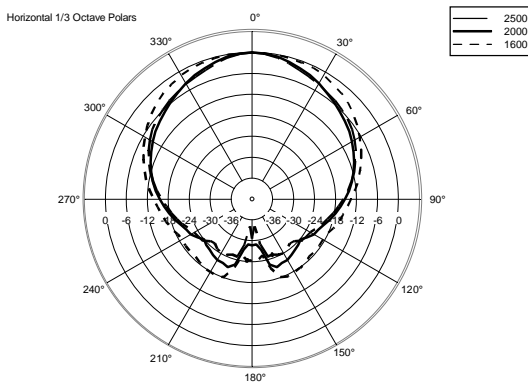
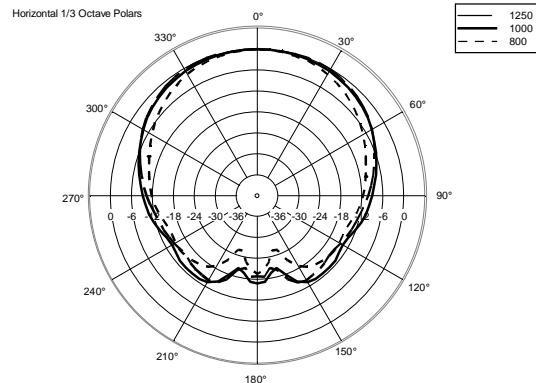
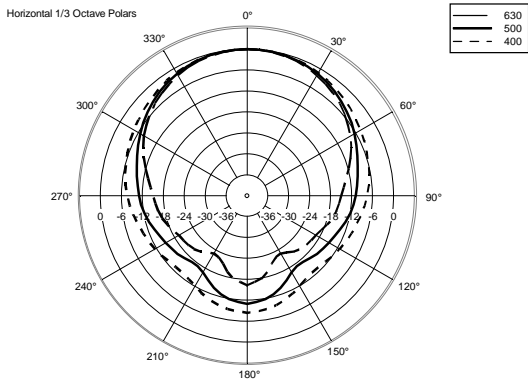
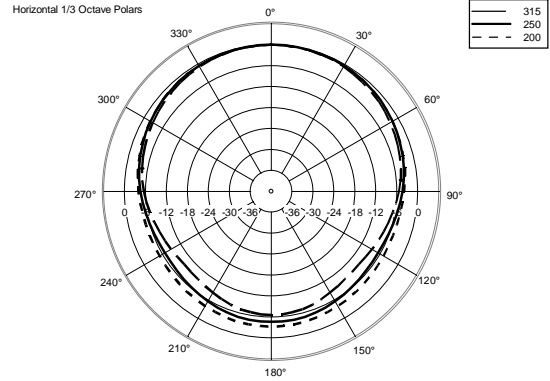
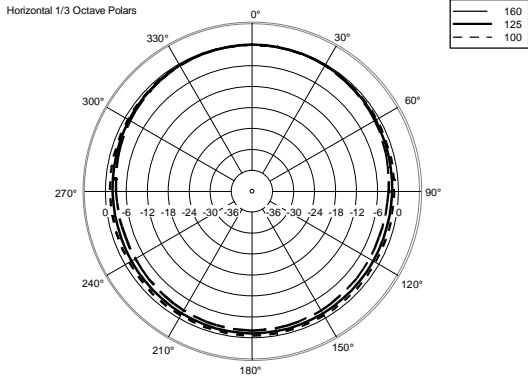

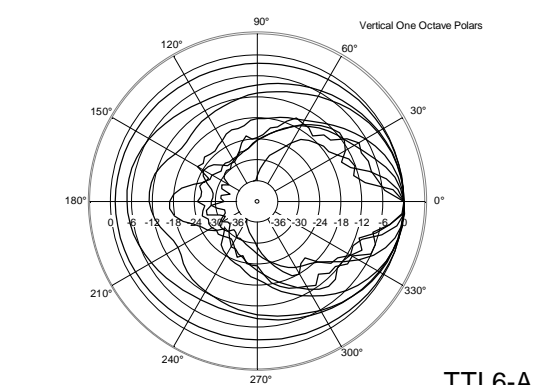
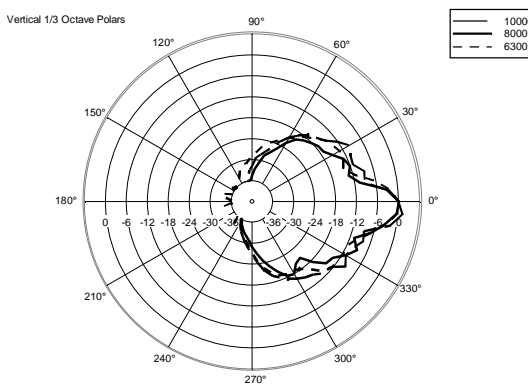
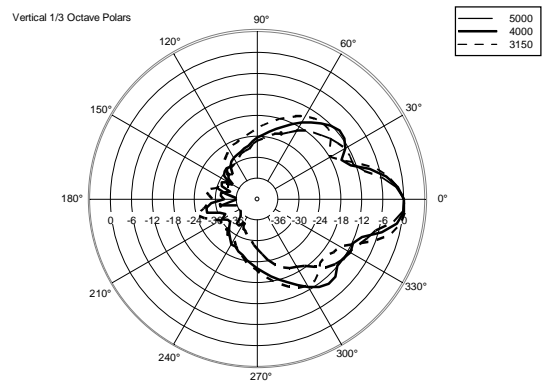
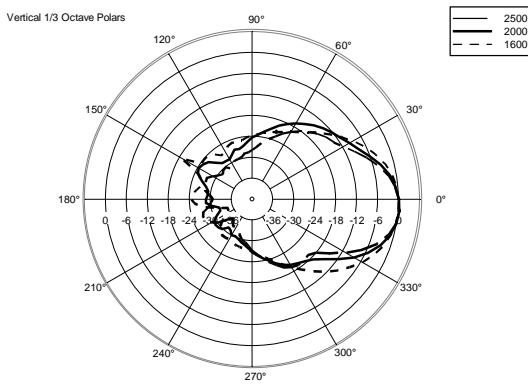
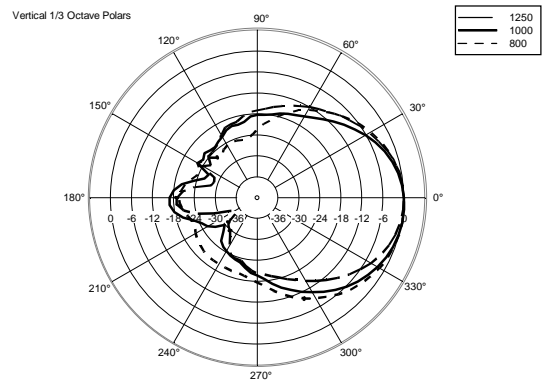
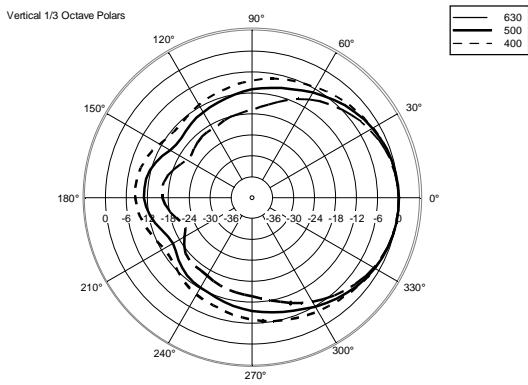
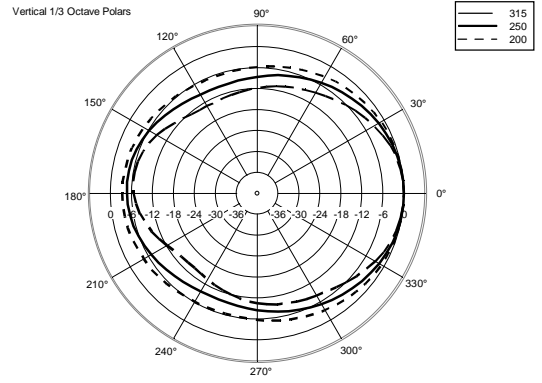
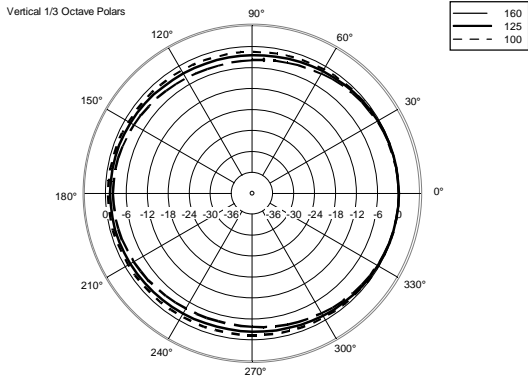

ACCESSORIES

AC 2X AZIMUT PLATE

PART NUMBER **13360351**
EAN: 8024530013516

AC PMX POLE MOUNT M20

PART NUMBER **13360232**
EAN: 8024530010058

AC POWER CABLE 6X TTL55

PART NUMBER **13360138**
EAN:

AC PRO-FS PROFESS. LOCKING FLOOR STAND

PART NUMBER **13360109**
EAN: 8024530006471

AC PRO-PM PROFESS. LOCKING POLE MOUNT

PART NUMBER **13360110**
EAN: 8024530006488

CABLES KIT CBL ETHERCON 0.7M

PART NUMBER **12399016**
EAN: 8024530013844

CABLES KIT CBL ETHERCON 1.5M

PART NUMBER **12399017**
EAN: 8024530013851

CABLES KIT CBL ETHERCON 3M

PART NUMBER **12399035**
EAN: 8024530013868

CABLES KIT CBL ETHERCON 5M

PART NUMBER **12399018**
EAN: 8024530013875



CABLES KIT CBL ETHERCON TO XLR F 0.2M

PART NUMBER **12399019**
EAN: 8024530013882

CABLES KIT CBL ETHERCON TO XLR M 0.2M

PART NUMBER **12399020**
EAN: 8024530013899

CABLES KIT CBL LK 25 MULTIPIN 10M

PART NUMBER **12399023**
EAN: 8024530013837

CABLES KIT CBL LK 25 MULTIPIN 20M

PART NUMBER **12399022**
EAN: 8024530013820

CABLES KIT CBL LKS 19 ARRAY FANOUT

PART NUMBER **12399024**
EAN: 8024530013905

CABLES KIT CBL LKS 19 BREAKOUT

PART NUMBER **12399026**
EAN: 8024530013929

CABLES KIT CBL LKS 19 POWER 10M

PART NUMBER **12399027**
EAN: 8024530013936

CABLES KIT CBL LKS 19 SUB FANOUT

PART NUMBER **12399025**
EAN: 8024530013912

CABLES KIT CBL LKS 25-2 FANOUT

PART NUMBER **12399021**
EAN: 8024530013813

CABLES KIT CBL POWER BOX 6X

PART NUMBER **13360145**
EAN: 8024530015534



CABLES KIT CBL POWERCON LINK 0.7M

PART NUMBER **12399031**
EAN: 8024530013738

CABLES KIT CBL POWERCON LINK 1.5M

PART NUMBER **12399030**
EAN: 8024530013721

CABLES KIT CBL POWERCON LINK 10M

PART NUMBER **12399028**
EAN: 8024530013707

CABLES KIT CBL POWERCON LINK 5M

PART NUMBER **12399029**
EAN: 8024530013714

FLY BAR FL-B TTL 6

PART NUMBER **13360349**
EAN: 8024530013585

FLY BAR PICKUP FL-B PK HDL 20-18

PART NUMBER **13360221**
EAN: 8024530018221

HOIST SPACING CHAIN CH 001

PART NUMBER **13360129**
EAN:

LKS 19-20 POWER CABLE

PART NUMBER **13360146**
EAN: 8024530013943

QUICK LOCK PIN QL-PIN D9.6 L31 4X

PART NUMBER **13360222**
EAN: 8024530015787