

GO:LIVECAST

Owner's Manual



Before using this unit, carefully read "USING THE UNIT SAFELY."
After reading, keep the document(s) where it will be available for
immediate reference.

Panel Descriptions

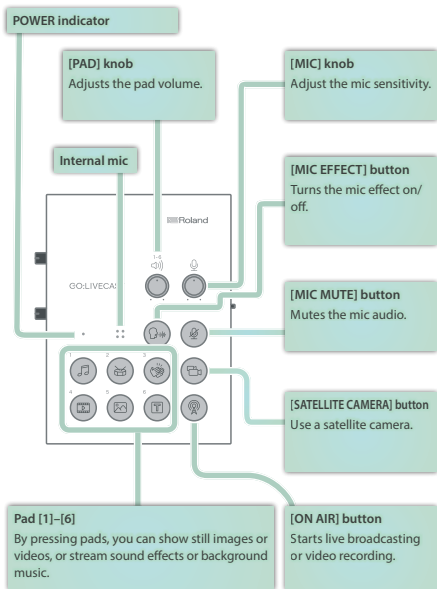

Connecting the Equipment

About the Included USB Cables

The following USB cables are included with this unit.

Use only the included USB cables to connect a USB power adaptor or a smartphone. Do not use the included USB cables to connect anything other than this unit.

- **USB Type-A to USB Micro-B type cable**

Use this to connect a USB power adaptor.

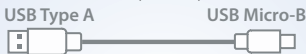

- **Lightning to USB Micro-B type cable**

Use this to connect the unit to an iPhone or iPad.



- **USB Type-C™ to USB Micro-B type cable**

Use this to connect the unit to an Android smartphone.



Connecting a USB Power Adaptor (Turning the Power On)

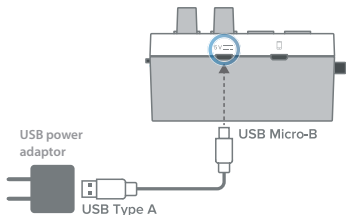

Use the included USB Type-A to USB Micro-B type cable to connect a USB power adaptor (sold separately) to the USB POWER port. Connect the USB power adaptor to an electrical outlet.

- * Use a commercially available USB power adaptor.
- * Before turning the unit on/off, always be sure to turn the volume down. Even with the volume turned down, you might hear some sound when switching the unit on/off. However, this is normal and does not indicate a malfunction.

Outdoor Use

When using the unit outdoor, you can supply power from a mobile battery (sold separately) instead of an AC outlet.

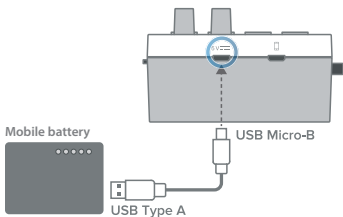

- * Use a commercially available mobile battery.

Connecting a Smartphone

Connecting an iPhone or iPad

1. Using the included Lightning to USB Micro-B type cable, connect your iPhone or iPad to the USB SMARTPHONE port.

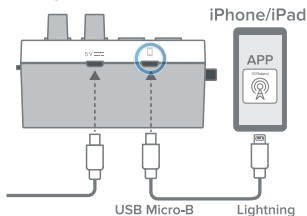

If this unit is powered-on when you connect a smartphone to it, this unit's POWER indicator will light.

2. Start the GO:LIVECAST app.

* You must make connections before you start the app.

Connecting an Android Smartphone

1. Using the included USB Type-C™ to USB Micro-B type cable, connect your Android smartphone to the USB SMARTPHONE port.

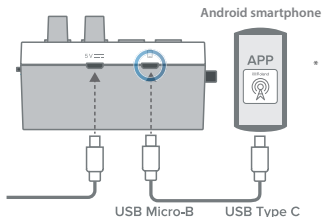

* If you're using an Android smartphone, first use the smartphone's volume buttons to adjust the volume, and then adjust the [HEADPHONE] knob.

If this unit is powered-on when you connect a smartphone to it, this unit's POWER indicator will light.

2. Start the GO:LIVECAST app.

* You must make connections before you start the app.

Connecting a Headphones

1. Connect your headphones, headset, or monitor speakers to the HEADPHONE/HEADSET jack.

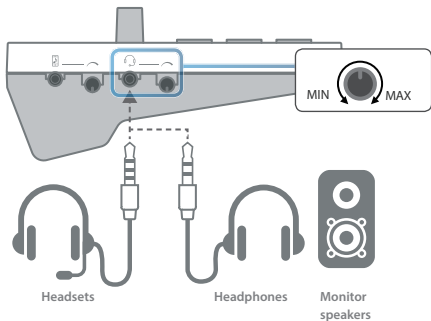

2. Use the [HEADPHONE] knob to adjust the overall volume.

- * This unit supports headphones that are equipped with a 3.5 mm mini-plug.
- * This unit supports headsets that are equipped with a CTIA-type 3.5 mm mini-plug (4-pole).
- * The mono-mixed audio is output from the HEADPHONE/HEADSET jack.
- * If you connect speakers, take care that the mic does not cause feedback. If a dynamic mic or condenser mic are connected, turning off the reverb might decrease feedback.
- * If speakers are connected, the internal mic cannot be used.

Connecting a Mic

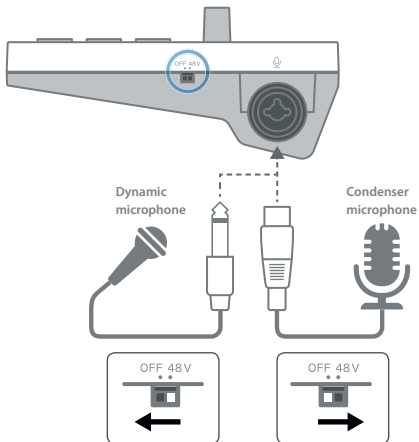

Pin assignment of MIC connector (XLR, TRS).

- 1: GND
- 2: HOT
- 3: COLD

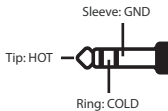

Dynamic microphone

You can connect a dynamic mic here. Set the [PHANTOM] switch "OFF." Connect it to the MIC jack via an XLR type, TRS type, or TS type plug.

Condenser microphone

You can connect a phantom-powered condenser mic here. Set the [PHANTOM] switch to "48V." (Phantom power: DC48 V, 6 mA Max) Connect it to the MIC jack via an XLR type plug.

Headsets

If a headset is connected, the headset's mic is used (p. 6).

- * Headsets equipped with a CTIA-type 3.5 mm mini-plug (4-pole) are supported.

Internal mic

If a mic (including a headset mic) is not connected, the internal mic is used (p. 2).

Adjusting the mic sensitivity

Use the [MIC] knob to adjust the mic's sensitivity.



While watching the level meter in the app, adjust the level so that it does reach the maximum.

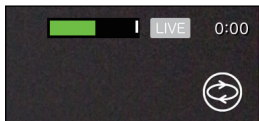

Muting the mic

When you're not using the mic, you can mute the mic audio by pressing the [MIC MUTE] button to make it light.



Connecting an Audio Player or Keyboard

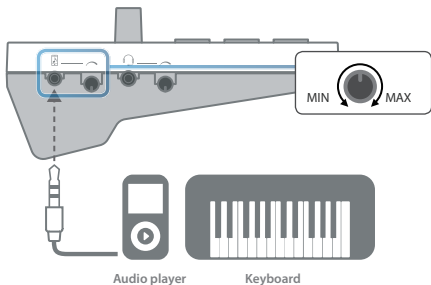

- 1. You can use a separately sold audio cable to connect an audio player or keyboard to the LINE IN jack.**

Make the connection via a 3.5 mm stereo mini-plug.

- 2. Use the [LINE IN] knob to adjust the volume of the connected device.**

- * To prevent malfunctions or damage, be sure to minimize the volume of all devices and turn off their power before making connections.
- * The sound that's input at LINE IN is mixed to mono.

Supplying Power to Your Smartphone During Use

By using a separately sold cable and accessory, you can use this unit while it supplies power to your smartphone.

Supplying power to your iPhone or iPad during use

Separately required items

- 1 Apple Lightning to USB 3 Camera Adapter
- 2 USB Type-A to USB Micro-B type cable
- 3 Lightning to USB Type-A cable
- 4 USB power adaptor (2 A or higher)

* Do not use a USB cable that is designed only for charging a device. Charge-only cables cannot transmit data.

Connect the items to your iPhone or iPad as shown in the illustration.

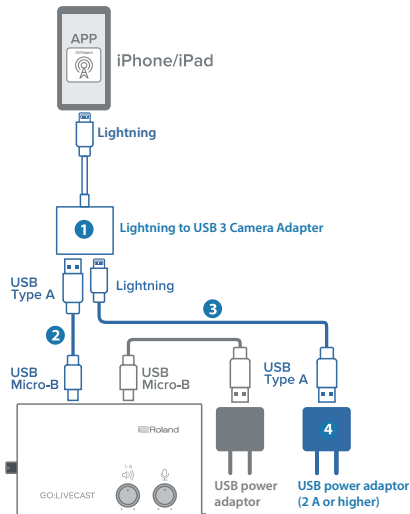

Supplying power to your Android smartphone during use

Separately required items

- 1 Apple USB-C Digital AV Multiport Adapter
- 2 USB Type-A to USB Micro-B type cable
- 3 USB Type-C™ to USB Type-A cable
- 4 USB power adaptor (2 A or higher)

* Do not use a USB cable that is designed only for charging a device. Charge-only cables cannot transmit data.

* Some Android smartphones cannot be used while being charged. Refer to <http://roland.cm/golivecastcp> for information on supported models.

Connect the items to your Android smartphone as shown in the illustration.

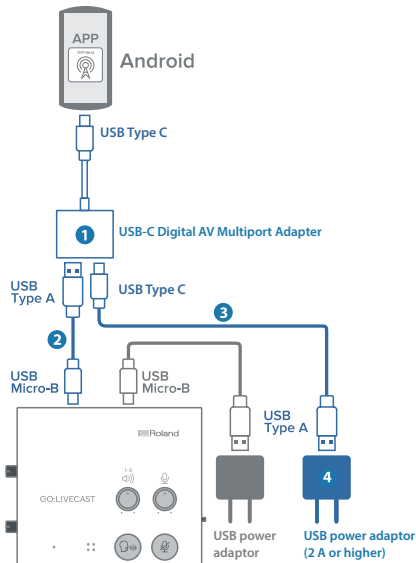

Opening Screen

When you start the GO:LIVECAST app without connecting the GO:LIVECAST, the opening screen appears.

If the GO:LIVECAST is connected, the opening screen is automatically skipped, and the main screen appears (p. 13).

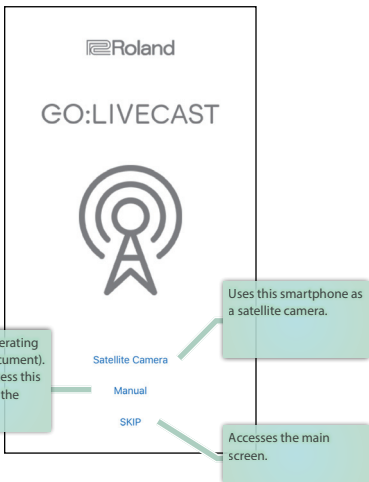

NOTE

- Even if your equipment is connected, you can't play or hear sound from the GO:LIVECAST unless the GO:LIVECAST app is running.
- You can't live-broadcast or record video using just the GO:LIVECAST app by itself.

Main Screen

This is the main screen of the GO:LIVECAST app. Use the buttons in the screen to switch the functions.

LIVE/REC indication

Elapsed time

Camera switch

Switch the camera that's used. By default, this is the front camera.

* On Android, you can't switch the camera while streaming or recording video.

Level meter

Beauty filter

Uses the beauty filter.

Live set

Save and recall frequently-used settings.

Setting

Make various settings for the GO:LIVECAST app.

* Settings cannot be made while streaming or recording.

Pad assign

Assign clips to pads [1]-[6].

Comment

Show comments during live broadcasting.

Satellite camera

Use as a satellite camera.

Mic effect

Specify the effect applied to the mic.

BROADCAST

Select the broadcast destination.

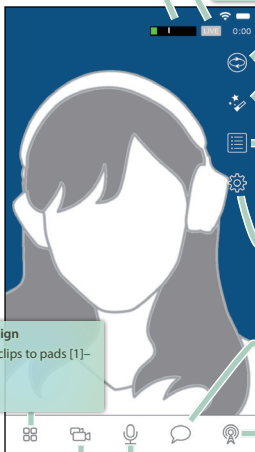

* On Android, use the [Back] button provided by Android OS to return from each setting screen to the main screen.

Using the Pads

You can use the pads of the GO:LIVECAST to play background music or sound effects, or to show video or text in the screen.

Playing Background Music or Sound Effects

With the default settings of the app, sound clips (such as background music and sound effects) are assigned to pads [1]–[3]. Press pads [1]–[3] one at a time to hear the sounds.

1. Press the pad that you want to hear.

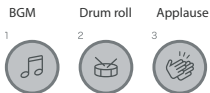

The pad is lit and you hear the sound.

2. Use the [PAD] knob to adjust the volume.

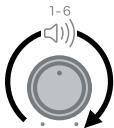

3. To stop the sound, press the pad once again to make it go dark.

MEMO

You can freely change the pad assignments (p. 24).

Showing Video or Photos in the Screen

With the default settings of the app, a video clip is assigned to pad [4] and a still image is assigned to pad [5].

Press pads [4] and [5] one at a time to see what they do.

1. Press pad [4] or [5].



The pad is lit, and a video or still image is shown layered onto the camera image.

2. Use the [PAD] knob to adjust the volume.

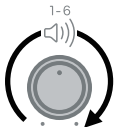

If the video includes audio, you hear the sound during playback.

3. To stop showing this, press the pad once again to make it go dark.

MEMO

You can freely change the pad assignments and the position at which the clip is shown (p. 20).

Showing Text in the Screen

With the default settings of the app, text is assigned to pad [6].
Press pad [6] to see what it does.

1. Press pad [6].

Text

6



The pad is lit, and a caption is shown layered onto the camera image.

2. To stop showing this, press the pad once again to make it go dark.

MEMO

You can freely change the text that is shown, as well as its font, size, position, and color (p. 22).

Changing the Clip Assigned to a Pad

For example, if a sound effect is assigned to a pad, you can assign a different sound effect to that pad.

1. Tap [Pad Assign].

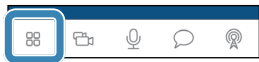

The assign screen appears.

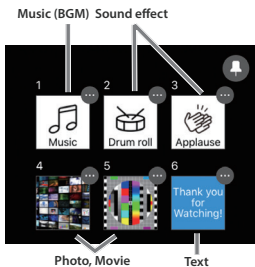

Thumbnails are shown to indicate the type of clip that is currently assigned to each pad. When you tap a thumbnail 1–6 in this screen, the assigned clip is reflected in the screen or the sound.

2. Tap the [...] icon shown at the upper right of the thumbnail for the pad that you want to reassign.

A setting screen for each clip appears.

3. Select the desired clip, and tap [Done].

4. Tap [Pad Assign] to return to the main screen.

Changing the Type of Clip Assigned to a Pad

You can freely assign clips to the pads of the GO:LIVECAST. For example, you could assign photos to all of the pads.

Selecting the Type of Clip

For each pad, you can select the type of clip that's assigned.

1. Tap [Pad Assign].

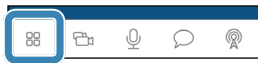

The assign screen appears.

Music (BGM) Sound effect

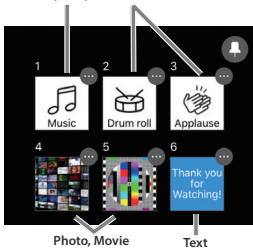

Thumbnails are shown to indicate the type of clip that is currently assigned to each pad. When you tap a thumbnail 1–6 in this screen, the assigned clip is reflected in the screen or the sound.

2. Tap the pin icon shown in the upper right of the assignment screen.

The color of the pin icon changes to red.

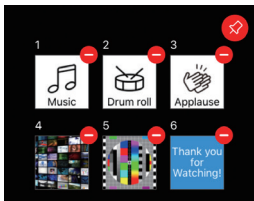

In this example, you'll temporarily clear the assignment of pad [3] and then assign a different type of clip.

3. Tap the [-] icon located at the upper right of the pad [3] thumbnail.

You can do the same thing by long-pressing the thumbnail.

iOS only

4. When the confirmation screen appears, tap [Clear].

The pad [3] thumbnail changes to the "No clip assigned" state.

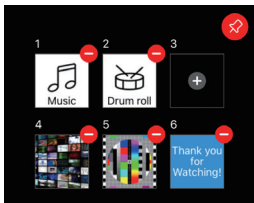

5. Tap the pin icon located in the upper right of the assignment screen, returning it to its previous state.
6. Tap the pad [3] thumbnail.

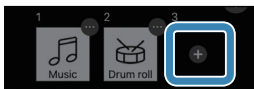

The clip select screen appears.

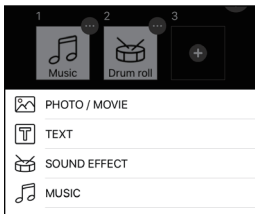

7. Tap the type of clip that you want to assign.

The screen for the selected type of clip appears.

Assigning Photos or Videos

1. In the clip select screen, tap "PHOTO/MOVIE."

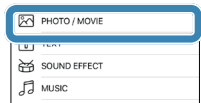

The "Photo/Movie" select screen appears.



Clips

Shows clips to assign.

Edit

iOS only

You can delete a loaded file. On Android, directly swipe the clip to the right.

Library

Import a clip from the camera roll of your smartphone.

2. Tap the thumbnail of the photo or video that you want to assign.

The LAYOUT screen appears.



Layout switching button

Tap this to switch the position of the clip.

(Top, bottom, full-screen)

3. When you've specified the layout, tap [Done].



The selected clip is assigned to pad [2].

4. Tap [Pad Assign] to return to the main screen.



Assigning Text

1. In the clip select screen, tap "TEXT."

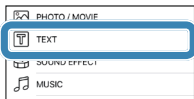

The "Text" setting screen appears.

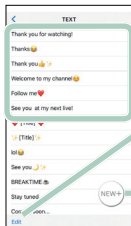

Text list

A list of previously-entered texts.

Edit

iOS only

You can delete previously-entered text. On Android, directly swipe the text list to the right.

NEW+

Enter the new text.

2. Tap to select the text that you want to assign. To enter next text, tap [NEW+].

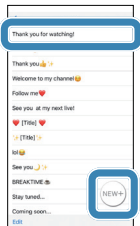

The edit screen appears.

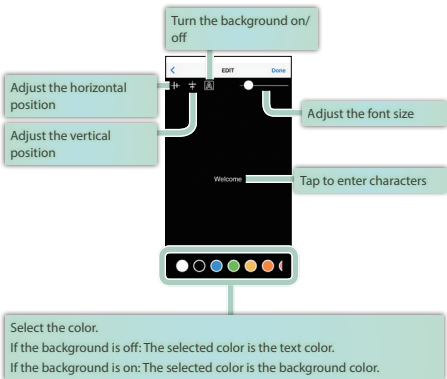

3. Adjust the character size, position, and color as necessary.

4. When you've specified the layout, tap [Done].

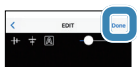

The selected text is assigned to pad [2].

5. Tap [Pad Assign] to return to the main screen.

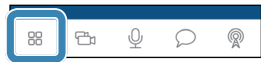

Assigning a Sound Effect

1. In the clip select screen, tap “SOUND EFFECT.”

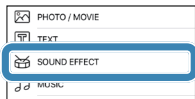

The “Sound Effect” select screen appears.

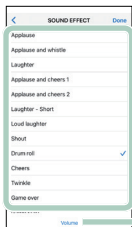

Sound effect list
Lists the sound effects that you can assign.

Volume
Specifies the volume of the sound effect.

2. Tap the sound effect that you want to assign.
When you tap, the selected sound effect is heard.
3. When you've adjusted the volume, tap [Done].



The selected sound effect is assigned to pad [2].

4. Tap [Pad Assign] to return to the main screen.



Assigning Background Music

1. In the clip select screen, tap "MUSIC."

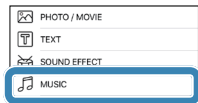

The "Music" select screen appears.



Music list

Lists the songs that you want to assign.

Library

Import a song from the smartphone's library.

* Songs with digital rights management (DRM) cannot be imported.

Volume

Set the volume of the song.

Edit

You can delete a loaded song. On Android, directly swipe the song list to the right.

iOS only

2. Tap the song that you want to assign.

You can tap to audition the selected song.

3. When you've adjusted the volume, tap [Done].



The selected song is assigned to pad [2].

4. Tap [Pad Assign] to return to the main screen.



Using the Mic Effect

You can apply reverb (reverberation) to the sound of the mic.

1. Tap [Mic Effect].



The effect slider appears.

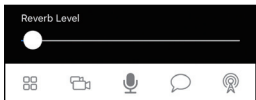

2. Drag the slider to adjust the amount of reverb.
3. Tap [Mic Effect] to return to the main screen.

Using the Beauty Filter

When you use the beauty filter, the image shown by the camera is given skin tones similar to the results of cosmetic treatment.

1. Tap [Beauty Filter].



The beauty filter turns on.

The effect is applied only to the image shown by the camera.

2. To turn it off, tap [Beauty Filter] once again.

Live Broadcasting

Now let's try actually live broadcasting.

MEMO

You can also record the video content on your smartphone (p. 37).

Specifying the Screen Orientation

iOS only

In this document, we explain the various screens of the GO:LIVECAST app in vertical orientation (portrait mode), but you can also use and broadcast the GO:LIVECAST app in horizontal orientation (landscape mode). The live broadcast video is also broadcast as a vertical screen when using portrait mode or as a horizontal screen when using landscape mode.

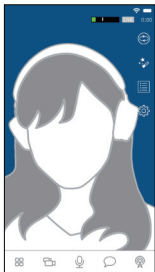

Portrait mode



Landscape mode

Selecting the Broadcast Destination

You'll need to make some settings before you broadcast.

In order to broadcast, your smartphone must be able to connect to the internet.

1. Tap [Broadcast].



The broadcast setting screen appears.

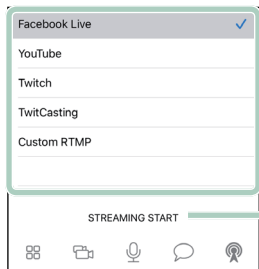

Platform list

A list of the broadcast destination platforms.

* For some models of smartphone, some platforms might not appear in the list. In this case, you can swipe the list up or down to view all platforms.

STREAMING START

Start live broadcasting.

2. Tap the platform on which you want to broadcast.

Each platform has a different screen for broadcast settings. Make the settings that are required for each platform.

Broadcasting on Facebook Live

In advance, create a Facebook account.

1. In the platform list, select Facebook Live.

The setting screen appears.

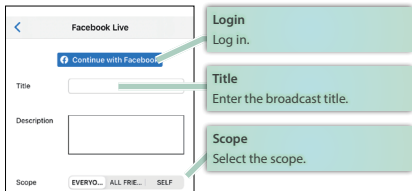

2. Tap [Log in] and log in to your Facebook account.

3. Tap [Title] and enter a title for your broadcast.

4. Select Scope.

Scope refers to the range of viewers to whom the broadcast is available. For example, you could specify that only your friends can watch it, or that only you yourself can watch it.

Value	Explanation
EVERYONE	Everyone can watch
ALL FRIEND	Only your friends can watch
SELF	Only you can watch

- * If you are streaming only to your friends, comments from your friends are not shown.
- * The first time you log in, you will be asked to specify the extent that you want to make your stream available; in this case, select Public. Each time you stream, you can specify the extent of availability.



5. When you finish making settings, tap [**<**] to return to the previous screen (iOS only).

* On Android, use the [Back] button provided by Android OS.

6. Tap [STREAMING START] or press the [ON AIR] button.



7. If a confirmation message appears in the screen, tap [START] or press the [ON AIR] button once again to start streaming.

Broadcasting on YouTube

In advance, create a Google account.

- * An account must have at least 1,000 channel subscribers in order to broadcast (as of September 2019). You must also enable live broadcasting on the channel. For details, refer to YouTube's support information.

1. In the platform list, select YouTube.

The setting screen appears.

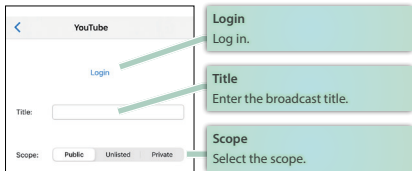

2. Tap [Log in] and log in to your Google account.

3. Tap [Title] and enter a title for your broadcast.

4. Select Scope.

Scope refers to the range of viewers to whom the broadcast is available. For example, you could specify that only your friends can watch it, or that only you yourself can watch it.

Value	Explanation
Public	Anyone can find and watch
Unlisted	Only people who know the link can watch
Private	Only you can watch

5. When you finish making settings, tap [<] to return to the previous screen (iOS only).

- * On Android, use the [Back] button provided by Android OS.

6. Tap [STREAMING START] or press the [ON AIR] button.



7. If a confirmation message appears in the screen, tap [START] or press the [ON AIR] button once again to start streaming.

Broadcasting on Twitch

In advance, create a Twitch account.

* In order to stream, two-step authentication must be enabled in the Twitch settings (as of September 2019). For details, refer to Twitch support information.

1. In the platform list, select Twitch.

The setting screen appears.

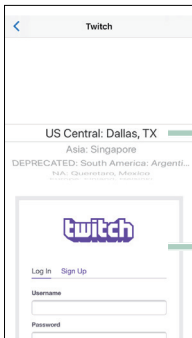

Streaming-destination server

Login
Log in.

2. Select the streaming-destination server.

3. In the log-in screen, enter your user name and password to log in.

4. When you finish making settings, tap [<] to return to the previous screen (iOS only).

* Tap [<] to return to the previous screen. On Android, use the [Back] button provided by Android OS.

5. Tap [STREAMING START] or press the [ON AIR] button.

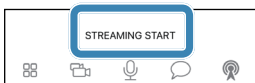

6. If a confirmation message appears in the screen, tap [START] or press the [ON AIR] button once again to start streaming.

Broadcasting on TwitCasting

In advance, create a TwitCasting account (a unique account for TwitCasting).

1. In the platform list, select TwitCasting.

The setting screen appears.

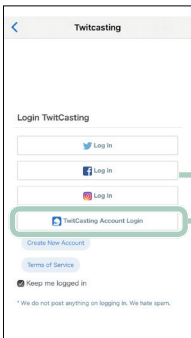

Log in using an SNS account.

Log in using a TwitCasting account.

2. Tap [TwitCasting Login] to log in.

If you have a social networking service (SNS) account such as on Twitter, Facebook, or Instagram, you can also use that account to log in.

3. When you finish making settings, tap [<] to return to the previous screen (iOS only).

* Tap [<] to return to the previous screen. On Android, use the [Back] button provided by Android OS.

4. Tap [STREAMING START] or press the [ON AIR] button.

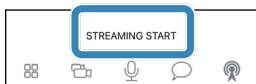

5. If a confirmation message appears in the screen, tap [START] or press the [ON AIR] button once again to start streaming.

Manually Specifying the Broadcast Destination

You can manually specify the broadcast destination without using an existing platform.

- * Checking that streaming to Periscope or SHOWROOM is being done in landscape mode.

1. In the platform list, select Custom RTMP.

The setting screen appears.

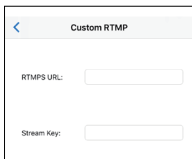

2. Enter the necessary information.

3. When you finish making settings, tap [<] to return to the previous screen (iOS only).

- * Tap [<] to return to the previous screen. On Android, use the [Back] button provided by Android OS.

4. Tap [STREAMING START] or press the [ON AIR] button.



5. If a confirmation message appears in the screen, tap [START] or press the [ON AIR] button once again to start streaming.

Viewing Comments

While broadcasting, you can view SNS comments.

* If you are connected via Custom RTMP, comments cannot be viewed.

1. Tap [Comments].



The comment screen appears.

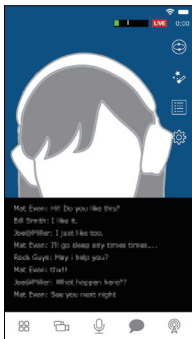

When a comment is input, it appears in the screen.

You cannot enter a comment yourself.

2. Tap [Comment] to return to the main screen.

MEMO

If you are broadcasting via YouTube, you can hide users who comment.

Tap a comment to select a user. Then tap one of the following buttons.

Button	Explanation
[SHOW URL]	The user's channel URL is shown as a popup.
[TIMEOUT]	The user will be unable to comment for five minutes.
[HIDE]	The user's comments will no longer be shown.

1. In the broadcast settings screen, tap [Stop Broadcasting] or press the [ON AIR] button to stop broadcasting.

Recording Video

The video content that you capture using the GO:LIVECAST can be video-recorded on your smartphone instead of being broadcast.

1. Tap [Settings].

The SETTINGS screen appears.



2. Turn [Record Mode] on.



3. Tap [<] to return to the main screen (iOS only).

* Tap [<] to return to the previous screen. On Android, use the [Back] button provided by Android OS.

4. In the broadcast settings screen, tap [RECORD START] or press the [ON AIR] button.

5. If a confirmation message appears in the screen, tap [START], or press the [ON AIR] button once again to start recording.

6. In the broadcast settings screen, tap [RECORD STOP] or press the [ON AIR] button.

7. If a confirmation message appears in the screen, tap [STOP], or press the [ON AIR] button once again to stop recording.

MEMO

The recorded video is saved in the camera roll of your smartphone.

NOTE

You can't broadcast while recording video.

Making Settings for the App

Here's how to make settings for the entire GO:LIVECAST app.

1. Tap [Settings].

The SETTINGS screen appears.

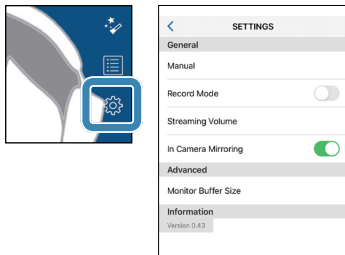

2. Specify the desired item.

Setting item	Value	Explanation
Manual	–	Shows this document.
Record Mode	Off, On	Video-records instead of broadcasting.
Streaming Volume	1–10	Specifies the volume of the broadcast.
In Camera Mirroring	Off, On	Flips the front camera image left-to-right.
Monitor Buffer Size	–	Adjusts the sound that is heard from the HEADPHONE/HEADSET jack. If you're using a low-spec smartphone, increasing this value might decrease audio dropouts. This will not affect the sound of the broadcast or the video recording.
Information	–	Shows the version of the GO:LIVECAST app.

3. Tap [<] to return to the main screen (iOS only).

* Tap [<] to return to the previous screen. On Android, use the [Back] button provided by Android OS.

Using as a Satellite Camera

By using the satellite camera function, the image from the camera of another smartphone can be shown in the GO:LIVECAST app. You can alternately switch between the images from the two cameras, or show the video from both in a split screen, and live-broadcast that video.

NOTE

- The GO:LIVECAST app must be installed both on the main smartphone (the one that's connected to the GO:LIVECAST unit) and on the satellite smartphone.
- Both the main and the satellite smartphone must be connected to the same Wi-Fi.

MEMO

- When using this outdoors, you can use your smartphone's Personal Hot Spot function to connect the main and satellite phones so that the satellite camera can be used even when there's no Wi-Fi router (iOS only).

MAIN

Operation on the main smartphone.

SATELLITE

Operation on the satellite smartphone.

1. **MAIN** Connect the main smartphone to the GO:LIVECAST, and start the GO:LIVECAST app.
2. **MAIN** Tap [Satellite Camera].



The satellite camera setting screen appears.

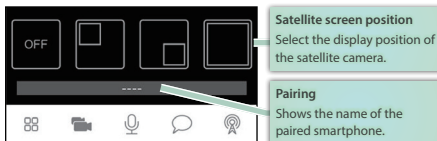

- 3. SATELLITE** On the satellite smartphone, start the GO:LIVECAST app.

The opening screen appears.

- 4. SATELLITE** Tap [Satellite Camera].

The screen waits to connect.



Pairing begins automatically.

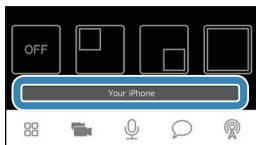

When pairing is successful, the name of the satellite smartphone appears in the pairing field of the main smartphone's satellite camera setting screen. Now you can use the satellite camera.

5. **MAIN** Tap the satellite screen position icon to specify the display position of the satellite camera.

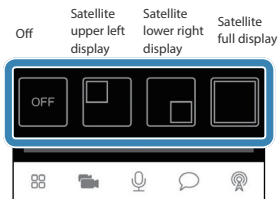

You can also switch the satellite camera's display position during the broadcast.

6. **SATELLITE** On the satellite smartphone, adjust the satellite camera's video.

Satellite camera's screen

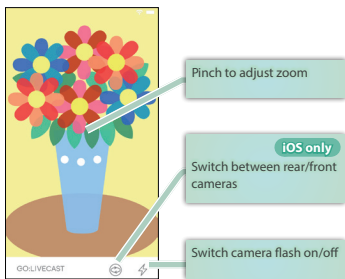

7. **MAIN** Tap [Satellite Camera] to return to the main screen.

Using Live Sets

Live set is a function that collectively saves the assignments of each pad as a set, letting you use different sets as appropriate for the content that you're streaming. Live sets that you created can be freely recalled.

Recalling a Live Set

1. Tap [Live Set].

The live set screen appears.



Live set list

Lists the live sets that you created.

Edit

iOS only

Deletes a live set that you created. On Android, directly swipe the text list to the right.

Create new

Creates a new live set.

2. Tap the name of the live set that you want to recall.

3. When the confirmation screen appears, tap [Load].

The live set is loaded, and you return to the main screen.

Creating a Live Set

1. Tap [Live Set].

The live set screen appears.

2. Tap [Create New].

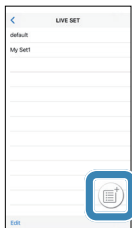

3. Enter a name for the live set.

4. Tap [Done] (iOS only).

The current settings are saved as a new live set, and added to the list.

5. Tap [<] to return to the main screen (iOS only).

* Tap [<] to return to the previous screen. On Android, use the [Back] button provided by Android OS.

Main Specifications

Roland GO:LIVECAST: Live Streaming Studio for Smartphones

Connectors	MIC jack	Combo type (XLR, 1/4-inch TRS phone, phantom power DC 48 V, 6 mA max.)
	LINE IN jack	Stereo miniature phone type
	HEADPHONE/HEADSET jack	Stereo miniature phone type (Stereo, CTIA)
	USB POWER port	USB Micro-B type
	USB SMARTPHONE port	USB Micro-B type
Controller	MIC knob	
	PAD knob	
	LINE IN knob	
	HEADPHONE knob	
Indicator	POWER indicator	
Current Draw	330 mA	
Dimensions	107 (W) x 138 (D) x 53 (H) mm	
	4-1/5 (W) x 5-2/5 (D) x 2 (H) inches	
Weight (excluding cables)	180 g	
	6 oz	
Accessories	Leaflet "Quick Start"	
	Leaflet "USING THE UNIT SAFELY"	
	Lightning to USB micro-B type cable	
	USB Type-C™ to USB micro-B type cable	
	USB Type-A to USB micro-B type cable	
	Registration Card (Only US)	

* This document explains the specifications of the product at the time that the document was issued. For the latest information, refer to the Roland website.
<https://www.roland.com/>

* For information about smartphone compatibility, access the following link.
<http://roland.cm/golivecastcp>

