

Instruction manual

Digital Conference System

ATUC-50

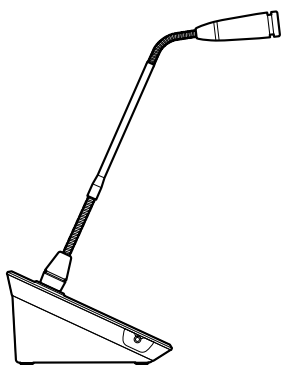

Gooseneck Microphone with LED Ring
ATUC-M43H/58H

Discussion Unit
ATUC-50DU

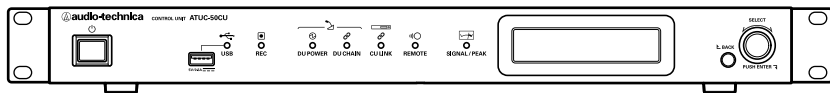

Control Unit
ATUC-50CU

Table of Contents

Introduction	3
About this manual.....	3
About the information in this manual	3
About registered trademarks and copyrights	3
Included accessories for the ATUC-50CU	3
System placement	3
Installing the CU(s) in a rack.....	3
Unbalanced connection.....	3
AC power cord connection.....	3
When cleaning the units.....	3
ATUC-50 System	4
Features	4
Features of ATUC-50 system	4
About Audio-Technica LINK.....	4
Features of ATUC-50CU.....	4
Features of ATUC-50DU.....	4
Features of ATUC-M43H/S8H.....	4
Connection example of digital conference system ATUC-50.....	5
Part Names and Functions	6
ATUC-50CU.....	6
Front panel.....	6
Rear panel.....	8
ATUC-50DU	9
ATUC-M	10
Changing settings from ATUC-50CU	11
Entering letters	12
System Connections and Configuration	13
Connecting devices	13
1 Connecting the DUs to the CU	13
2 Connecting the DUs together.....	14
3 Connecting the microphone ATUC-M to the DU.....	18
4 Connecting an amplifier	18
5 Turning on the CU and testing DU operations	18
6 Connecting to a network	19
7 Connecting a computer or mobile device to a network	19
Preparing to use Web Remote	21
What is Web Remote?.....	21
Setting up “Locate”	21

Configuring and Operating Conferences Using the Web Remote Control Function.....	22
About Web Remote	22
Overall structure of Web Remote	22
Starting up Web Remote and preparing for operations	23
Starting up and logging in to Web Remote.....	23
About Web Remote Home screen	23
Configuring detailed system settings ([Settings & Maintenance])	24
How to operate the [Settings & Maintenance] menu	24
Menu item ① ([System Settings])	25
Menu item ② ([Install Settings]).....	29
Accessing your presets ([Presets])	37
Log management ([Logging])	37
Displaying the system information ([System Info]).....	37
Preparing for conferences ([Setup Conference])	38
1 Recalling the preset ([Recall Preset])	38
2 Changing the conference settings ([Conference Settings])	38
3 Adjusting the DU settings ([DU Settings], [DU Detail Settings]).....	39
Operating and controlling conferences ([Start Conference])	40
1 Operating conferences ([Conference Manager]).....	40
2 Configuring the advanced audio-related settings and performing audio operations ([Audio Control])	41
3 Configuring conference settings ([Conference Settings])	41
Information.....	42
Troubleshooting.....	42
ATUC-50CU.....	42
ATUC-50DU.....	43
Web Remote	44
Error messages	45
Specifications	48
ATUC-50CU specifications.....	48
General specifications	48
Input/output specifications	49
ATUC-50DU specifications	50
General specifications	50
Input/output specifications	50
ATUC-M specifications	51

Introduction

About this manual

About the information in this manual

The images and screenshots shown in this manual may differ from the actual product.

Device names

The device names are abbreviated as follows.

- CU: “Control Unit” ATUC-50CU
- DU: “Discussion Unit” ATUC-50DU
- ATUC-M: “Gooseneck Microphone with LED Ring” ATUC-M43H/ATUC-M58H

Symbols

- Indicates the page(s) where you can find more detailed or related information.

NOTICE Indicates a risk that may result in malfunction or damage to the device.

 Indicates supplementary information as well as tips & advice for operations.

[] Indicates menu items on the Web Remote screen.

Operations on mobile devices

Operations in this manual assume that you are using a computer as a control device. Alternatively you can use a mobile device such as a tablet. Instead of clicking or double-clicking, operate the application by tapping.

About registered trademarks and copyrights

- Apple, the Apple logo, iPad and Mac OS are trademarks of Apple Inc., registered in the U.S. and other countries. App Store is a service mark of Apple Inc.
- Google Play and the Google Play logo are registered trademarks or trademarks of Google Inc.
- Other product names, service names, logos and/or company names used in this manual are trademarked and copyrighted properties of their respective owners and/or licensors. In this manual, the TM and ® mark may not be specified.

Included accessories for the ATUC-50CU

The following accessories and documentation are provided.

- AC power cord
- Euroblock connector (9 pieces)
- Quick Setup Guide—English version

- Quick Setup Guide—Multi-language version

System placement

Installing the CU(s) in a rack

Rack requirements for the CU

- EIA standard compatible 19-inch rack
- 1U-size rack mounting
- Rack equipped with safety guardrails to support the CU and a board on which the CU is to be placed

When installing the CU(s) in a rack, keep the temperature within the rack below 45°C (113°F). High temperature may damage the internal components, causing a malfunction.

Leave a space of 10cm or more on each side (top, right and left, rear) between the CU and other devices or the rack.

Rack mounting angles are fixed to the CU using the following screws. When using screws other than those listed here, check the specifications.

- S TIGHT tapping screws with nominal diameter 4×6mm*
* Substitutable for M4×6mm machine screws

Unbalanced connection

Since induction noises tend to occur due to difference in electric potential of chassis:

- Keep the chassis between each device at the same electric potential.
- Use the same power system.
- Connect to the GND (ground) terminal or chassis ground of each device.

AC power cord connection

Be sure to connect the AC power cord into a properly grounded wall outlet. Improper grounding can cause electrical shock.

When cleaning the units

Do not use any solvents or chemicals such as benzine, thinner, alcohol or electrical contact cleaner and protector. Doing so may cause deformation, damage and malfunction of the units.

ATUC-50 System

Features

Features of ATUC-50 system

- Audio processing by the feedback processor and the like enables clear-sounding conversations
- Up to 150 conference microphones (ATUC-50DU + ATUC-M) can be connected
- Either daisy-chain or ring connection can be made with Cat5e or higher cables (shielded cables with conductor size of 24AWG or higher in diameter are recommended).
- 3 selectable conference modes: Free Talk Mode, Request Talk Mode, and Full Remote Mode
- The recording function enables you to record audio onto a USB device (mass storage device)
- Controllable using Web Remote and an external control device
- Design with future expansion considered

About Audio-Technica LINK

The system adopts the unique format Audio-Technica LINK for power supply and signal transmission between the control unit(s) (ATUC-50CU) and conference microphones (ATUC-50DU + ATUC-M).

Audio-Technica LINK is compatible with the Ethernet standards and allows a simple construction for universal Cat5e or higher cable connections. (A shielded cable with conductor size of 24AWG or higher in diameter is recommended.) Transmission of high-speed signals with low-latency allows stable control and uncompressed audio signal transmission.

Features of ATUC-50CU

- Controls up to 50 conference microphones (ATUC-50DU + ATUC-M) and supplies power to them
- Up to 150 conference microphones (ATUC-50DU + ATUC-M) can be connected by cascade-connection
- 4 configurable balanced matrix output plus 1 unbalanced output that outputs the same audio as Output 1
- 2 Mic/Line inputs, 2 monaural AUX inputs, and 2 return inputs
- 2 return channels are available for both bilingual simultaneous interpretation and the language of the floor holder
- Conference mode: Free Talk, Request Talk, and Full Remote
- Priority mode: First-press priority and later-press (FIFO, LIFO) priority
- Talk mode: Manual mode, Voice activation mode
- Web Remote enables you to easily change settings and control attendees' right to talk during conference

- Up to 4 channels (WAV: up to 4 channels, MP3: up to 2 channels) can be recorded on a USB device (mass storage device)
- Audio processing by the feedback suppressor and the like enables the control unit to deliver high-quality sound
- Design with future expansion and renewal considered

Features of ATUC-50DU

- An LED ring enables power supply via 3-pin balanced connector while offering both high sound quality and user flexibility
- ATUC-M and standard 3-pin microphone can be connected
- A microphone amplifier with discrete transistors reduces noise; moreover individual gain is adjustable
- A high-quality and high-resolution speaker
- Audio quality of 24bits/48kHz
- Multiple independent indicators (ATUC-M ring LED, multicolored LEDs both on the rear side and on the Ⓢ (talk) button)
- High-visibility indicators associated with the headphone volume adjustment buttons and monitor channel selection buttons
- Optional removable bottom weight for improved stability
- 2 ports of RJ-45 for connecting discussion units (ATUC-50DU) and 1 expansion RJ-11 port for future option
- 1 headphone output jack with a monitoring channel switch function

Features of ATUC-M43H/58H

- Equipped with an LED ring that enables power supply via 3-pin balanced connector while offering both high sound quality and user flexibility
- Adopted mechanics between the microphone connector and the discussion unit (ATUC-50DU) reduce vibration
- Adopted a double layer pop filter (windscreen inside the microphone)
- Improves RF measures against external radio waves
- 2 types of microphones (430mm and 580mm length)

Connection example of digital conference system ATUC-50

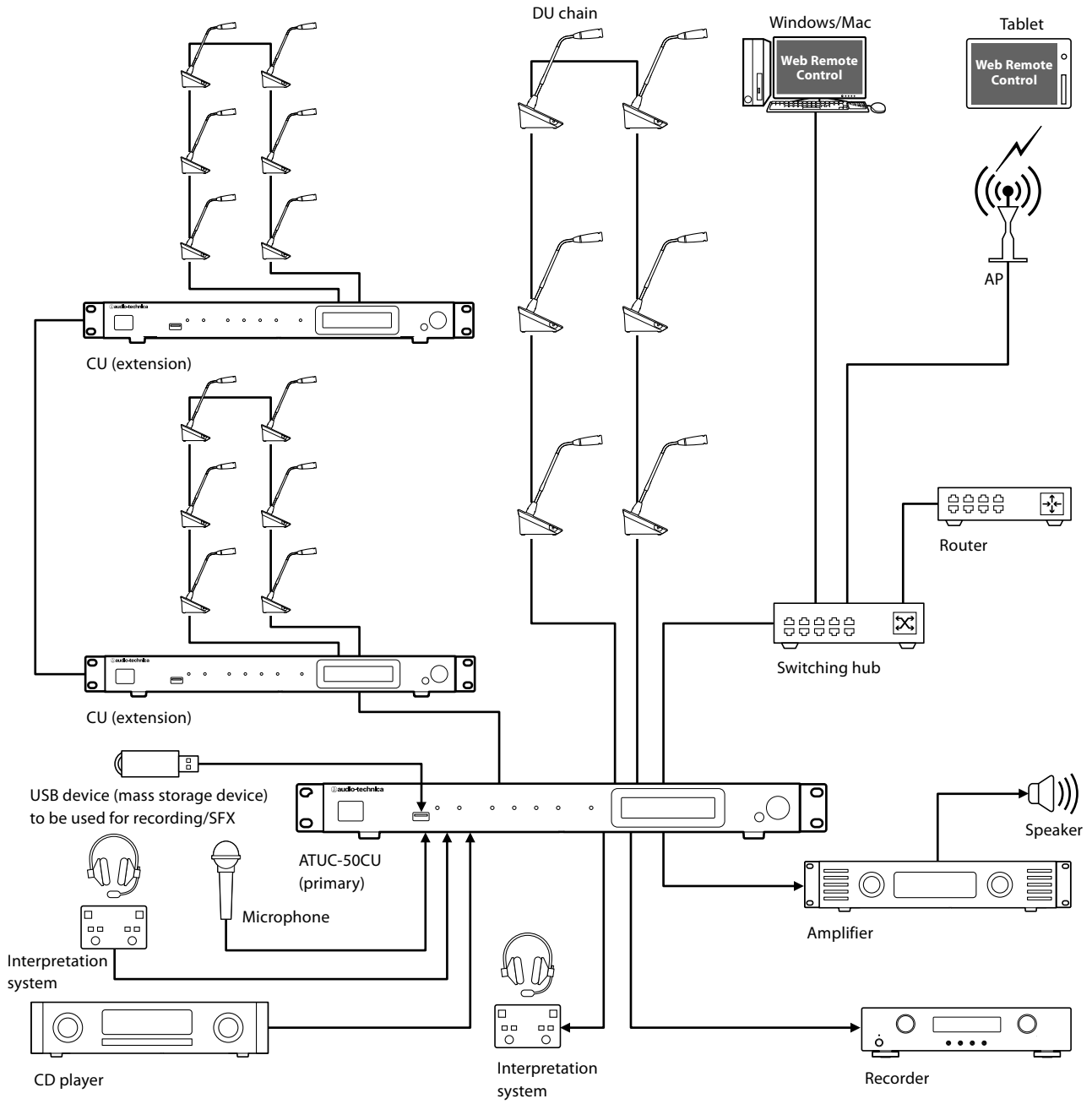

Part Names and Functions

ATUC-50CU

Front panel

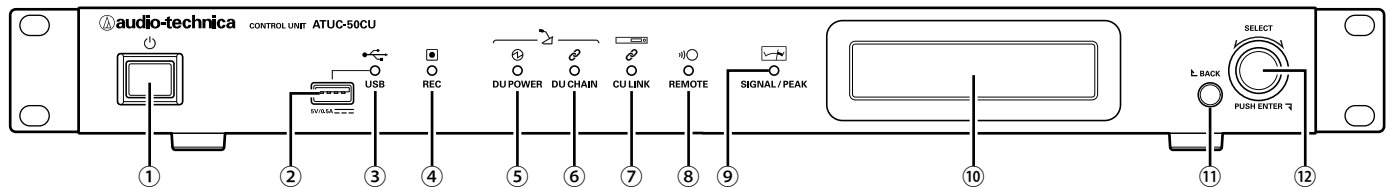

① Power switch

Turns the power of the CU on and off.

② USB terminal

The following operations can be performed by connecting a USB device (mass storage device) such as a USB flash drive or USB hard drive.

- Recording sound (▶ page 41)
- Playing buzzer and chime (▶ page 41)
- Importing/exporting preset data (▶ page 37)
- Upgrading the firmware (▶ page 27)

NOTICE • Supports FAT16 and FAT32 file systems

- Maximum storage capacity: 2TB
- Maximum file size: 2GB
- Does not support USB hubs.
- Do not use extension cables.
- Do not attempt to use USB devices (mass storage devices) that have been cracked, deformed or repaired using adhesive tape or the like.
- Do not save or create any files or folders unnecessary for this system on the USB device (mass storage device); doing so may affect system operations.
- The CU is not compatible with USB devices (mass storage device) with special functions such as a security function.

③ USB access indicator

Indicates the connection status of the USB device (mass storage device).

- In an access state: lit green

NOTICE • Do not remove the USB device (mass storage device) while the indicator is lit green; doing so may destroy data.

④ REC (recording) indicator

Indicates the recording status.

- In a recording state: lit green
- In a recording-pause state: blinks green
- While not recording: remains off

NOTICE • If you remove the USB device (mass storage device) while in a recording state or recording-pause state, the recorded file may not be written correctly. Do not remove the USB device (mass storage device) during recording.

⑤ DU POWER (DU power supply) indicator

- In a normal state: lit green
- In an abnormal state (such as when a voltage drop occurs in the 48V output system): blinks green
- In a DU disconnected state: remains off

⑥ DU CHAIN indicator

- In a normal state: lit green
- In an abnormal state (such as when failing in communication with a DU): blinks green
- In a DU disconnected state: remains off

⑦ CU LINK indicator

- In a CU Link state: lit green
- In an abnormal state (such as when failing in communication with a CU): blinks green
- In a CU Link cut-off state: remains off

⑧ Remote (remote control) indicator

- In a communication state: lit green
- In an abnormal state (such as when failing in external transmission retry): blinks green
- In a non-communication state: remains off

⑨ SIGNAL/PEAK indicator

Indicates the audio signal level as follows:

- 60dBFS or higher: lit green
- 20dBFS or higher: lit amber
- 2dBFS or higher: lit red

Adjust the audio signal level such that the indicator will not light red (▶ page 41).

⑩ CU display

⑪ BACK button

Returns to the previous or upper screen/item.

Press and hold this button to return to the HOME screen from any screen.

⑫ Jog dial/ENTER button

Rotate the jog dial to select the desired item and then press the ENTER button to confirm.

Rotating the jog dial also adjusts the setting values.

• Locking the operation buttons (Key Lock function)

Press the BACK button and ENTER button simultaneously for over 2 seconds to activate the Key lock function, and thus lock all front panel operations except for the Power switch.

• Unlocking the operation buttons

When the operation buttons are locked, press the BACK button and ENTER button simultaneously for over 2 seconds to unlock the operation buttons.

CU display and jog dial operations:

HOME screen

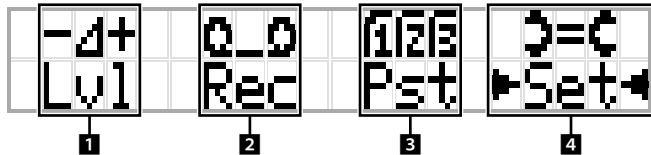

The item with ▶ ◀ is the currently selected item.

By rotating the jog dial, move ▶ ◀ to select the operation you want to perform and then press the ENTER button.

1 Master level adjustment (Lvl)

Master level

-50 -40 -30 -20 -12 -6 0 6 12 Peak (dBu)

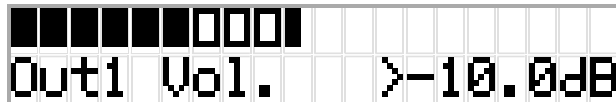

- Rotate the jog dial to adjust the CU output level (OUTPUT 1).
- While pressing the ENTER button, rotate the jog dial to adjust the level in 10-step increments.
- Be sure that the Peak indicator does not light up while adjusting the level.

2 Recording operations (Rec)

R (Remaining recording time)/E (Elapsed recording time) display

-50 -40 -30 -20 -12 -6 0 6 12 Peak (dBu)



- Rotate the jog dial to select *Rec* (Start recording)/*Pau* (Pause)/*Stp* (Stop)/*R* or *E* (Recording time display) and then press the ENTER button to confirm.
- Select the time display on the top right side of the screen using the jog dial and then press the ENTER button to switch the display between *R* (Remaining recording time)/*E* (Elapsed recording time).
- To adjust the recording level, move ▶ ◀ to the recording level meter at the top left of the screen to display *Rec Lvl* and then press the ENTER button to enter recording level adjustment mode. Rotate the dial to adjust the recording level being sure that the Peak indicator does not light up.
- While pressing the ENTER button, rotate the jog dial to adjust the level in 10-step increments.

3 Conference preparation (Pst)



- [1] *Recall Presets*: Rotate the jog dial to move ">" to the item you want to recall and then press the ENTER button to confirm.
- [2] *Conf. Setup*: Change or check the conference settings. Rotate the jog dial to move ">" to the item you want to change or check and then press the ENTER button to confirm.

Pst Menu Items:

Settings can also be configured via Web Remote. The item names in parentheses () are used for Web Remote.

[1] *Recall Presets*

[2] *Conf. Setup* (▶ page 34)

01 *Conference Mode* (Conference Mode)

02 *NOM* (Number of Open Mics)

03 *Auto Mic Off* (Auto Mic OFF)

04 *Override Mode* (Override Mode)

05 *Max Queue* (Maximum in Queue)

06 *MicON Trigger* (Mic ON Trigger / Mic ON Trigger for Priority)

07 *MicON Hold Time* (Mic ON Hold Time)

08 *Interrupt Option* (Interrupt Option)



• Items that can be configured from [2] *Conf. Setup* differ depending on the conference mode.

• For details on items, see "Menu items" (▶ pages 25 - 35).

4 Configuring settings (Set)

Rotate the jog dial to move ">" to the desired item or value and then press the ENTER button to confirm.

For details on setting items, see "Set Menu Items" (▶ page 11).

Rear panel

* The serial number label is located on the top panel.

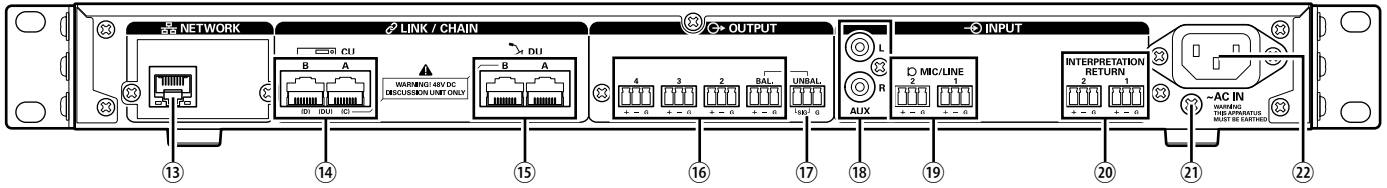

- NOTICE**
- Refer also to the instruction manuals supplied with the external devices.
 - Be careful NOT to connect the Ethernet cable from your network device to the CU LINK terminal or DU CHAIN terminal. This can cause damage to the connected device.

13 NETWORK terminal

- RJ-45
- Use for connecting to a local area network when controlling from an external device via the Web Remote Control or IP remote function (▶ page 19)

14 CU LINK A/B terminals, DU CHAIN C/D terminals

- RJ-45
- Use for cascading multiple CUs (▶ page 17). You can also configure these terminals as DU terminals (▶ page 14)

15 DU CHAIN A/B terminals

- RJ-45
- Use for connecting DUs. You can daisy-chain multiple DUs as well as ring multiple DUs using the A/B terminals



- By cascade-connecting multiple CUs, up to 150 DUs can be connected (▶ page 17).

16 Analog output (balanced) terminals: OUTPUT 1-4 (BAL)

- Euroblock
- Pin arrangement: “+” Hot/“–” Cold/“G” GND

17 Analog output (unbalanced) terminals: OUTPUT1 (UNBAL)

- Euroblock
- Pin arrangement: “SIG” Signal (2 systems)/“G” GND

18 Analog input (unbalanced) terminals: INPUT (AUX)

- RCA

19 Analog input (balanced) terminals: INPUT (MIC/LINE 1-2)

- Euroblock
- Pin arrangement: “+” Hot (supports phantom power)/ “–” Cold (supports phantom power)/“G” GND
- The input type can be switched between MIC and LINE (▶ page 29)

20 Analog input (balanced) terminal: INPUT (INTERPRETATION RETURN 1-2)

- Euroblock
- Pin arrangement: “+” Hot/“–” Cold/“G” GND
- Inputs audio signals from simultaneous interpretation system

21 Ground screw

Since the supplied AC power cord has a three-pronged plug, as long as your AC power wall outlet is grounded properly, the CU will also be grounded properly.

22 AC Inlet (AC IN)

Connect the supplied AC power cord.

- NOTICE**
- Do not plug in the AC power cord until all other connections have been completed.
 - Be sure that the CU is securely grounded to a single ground point. Grounding to multiple ground points can cause ground loops, resulting in noise generation such as a humming noise.

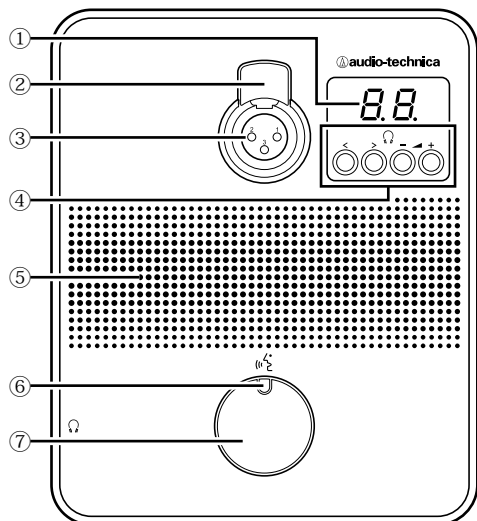

① DU display

When changing monitor channel or adjusting the volume level, the currently set value is displayed.

② Microphone release lever

③ Microphone jack

Connect a microphone.

- A typical 3-pin XLR type microphone as well as the ATUC-M series microphone can be connected.

④ </> Monitor channel selection buttons

When operating the </> monitor channel selection buttons, the currently selected monitor channel is displayed on the DU display ①.

FL: Monitors floor channel audio.

01-03: Monitors the audio of channels 1 to 3.

-/+ Headphone volume adjustment buttons

When operating the -/+ headphone adjustment buttons, the current volume level (0 to 20) is displayed on the DU display.

⑤ Built-in speaker

Outputs conference audio.

⑥ (talk) LED

Displays DU talk status.

- While talking: lit red
- When requested to talk (in standby mode): blinks green
- When talk request is rejected: blinks green (quickly blinks 4 times)

• The LED colors can be changed (▶ page 31).

⑦ (talk) button

Press this button to send a request to talk. Press the button again to finish talking or cancel the request to talk. DUs designated as a priority DU can cut other DU speakers short and mute other DUs by pressing this button.

Operations when the (talk) button is pressed briefly:

Conference mode	Current state	Mic ON Trigger mode	
		Button	Voice
Free Talk	Talk OFF	Talk ON	- (Not acceptable)
	Requesting to talk	Cancel request	
	Talk ON	Talk OFF	
Request Talk	Talk OFF	Request to talk	
	Requesting to talk	Cancel request	
	Talk ON	Talk OFF	
Full Remote	-	- (External control only)	

• On priority DUs, operations of the priority DUs are same as in Free Talk Mode regardless of the conference mode.

Operations when the (talk) button is pressed and held:

Only for Priority DUs with [Can Cut/Mute] set to on

Current state	Mic ON Trigger mode			
	Button	Voice	Button/Voice	
			Cut mode	Mute mode
	Press the button for 2 seconds or less		Press and hold the button for over 2 seconds	
Talk OFF	Talk ON	- (Not acceptable)	Talk ON(*1)	Talk ON(*2)
Talk ON	Talk OFF		Talk ON stays active(*1)	Talk ON stays active(*2)

*1 All specified DUs will be in Talk OFF state.

*2 All specified DUs will be in mute state.

ATUC-M

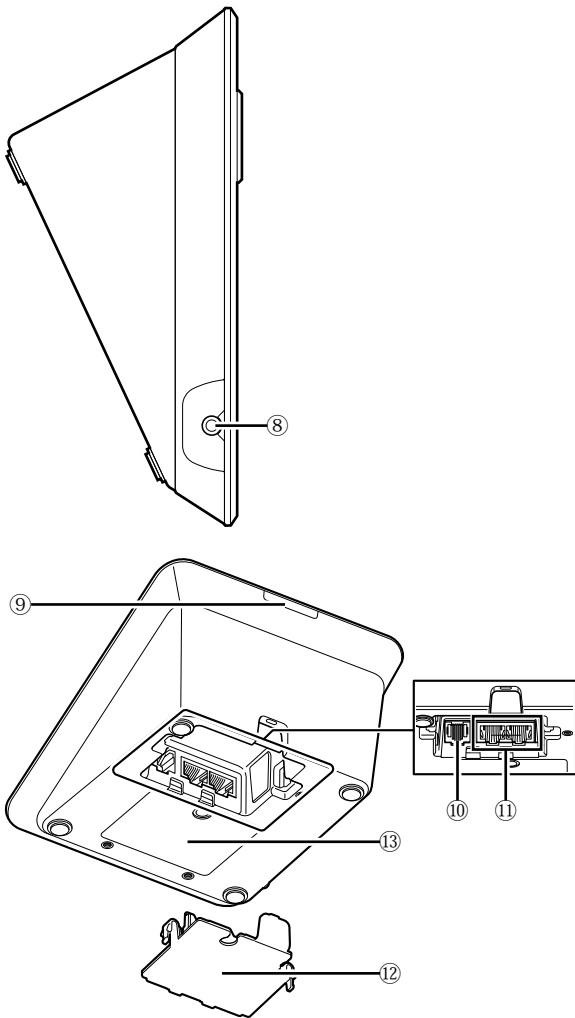

⑧ **Headphone jack**

⑨ **Rear LED**

The LED color can be set for each DU. It is useful when dividing DUs into groups by color. The LED color can be changed from Web Remote (▶ page 31).

⑩ **Extension terminal**

⑪ **DU/CU connection terminals (▶ page 13)**

⑫ **Bottom cover**

Covering the terminal part protects the terminals from dust and also prevents cables from becoming unplugged. Therefore, after connecting cables to each terminal, be sure to attach the bottom cover.

⑬ **Serial number**

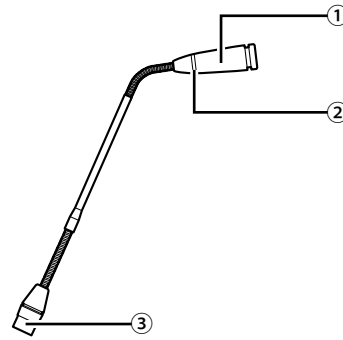

① **Microphone**

② **Ring LED**

Lights red when the microphone is activated.
Blinks red while waiting to talk.

③ **Connector**

Changing settings from ATUC-50CU

You can change CU settings by selecting “Set” on the HOME screen of the CU display. Changeable items are as follows.

For more detailed settings and settings of each DU, use Web Remote.



- After changing the network setting item(s), restart the CU to enable the setting values.

Set Menu Items

[1] System Setting (> page 25)	
01 Device Name	ATUC-50CU
02 Link Port Set	CU A/B, DU C/D
03 CU Link Mode	Primary, Extension 1, Extension 2
04 IP Setting	
01 IP Config Mode	Auto, Static
02 IP Address	0.0.0.0 - 255.255.255.255
03 Subnet Mask	0.0.0.0 - 255.255.255.255
04 Gateway Address	0.0.0.0 - 255.255.255.255
05 Allow Discovery	On, Off
06 IP Ctrl Setting	
01 IP Ctrl Port No	00001 - 65535
02 IP Ctrl Ntfy	On, Off
03 Audio Level Ntfy	On, Off
04 M-cast Adrs	0.0.0.0 - 255.255.255.255
05 M-cast Port No	00001 - 65535
07 Auto Mode Change	
01 Auto Mode Change	On, Off
02 Hold Time(Err)	20, 30, 40 seconds
08 NTP Setting	
01 NTP	On, Off
02 NTP Adrs	0.0.0.0 - 255.255.255.255
03 NTP Port	00001 - 65535
04 Time Zone	UTC -12:00 to +14:00
05 DST	On, Off
06 DST Start Date	1/1 - 12/31
07 DST Start Time	0:00 - 23:00
08 DST End Date	1/1 - 12/31
09 DST End Time	0:00 - 23:00
09 Login Password	
01 Admin.Pwd.Login	On, Off
02 Admin.Password	Displays password
03 Opr.Pwd.Login	On, Off
04 Opr.Password	Displays password
10 Reset All Dflt.	
[2] System Info (> page 37)	
01 Name	Displays current settings
02 Serial Number	
03 FW Version	
04 IP Config Mode	
05 IP Address	
06 Subnet Mask	
07 Gateway Address	
08 Mac Address	
09 Allow Discovery	
10 IP Ctrl Port No	
11 IP Ctrl Ntfy	
12 Audio Level Ntfy	
13 M-cast Adrs	
14 M-cast Port No	
15 NTP	
16 NTP Adrs	
17 NTP Port	
18 Time Zone	
19 CU Link Status	

20 No.ofExtensionCU	
21 Total No.of DU	
[3] Audio Setting (> page 29)	
01 MIC/LINE Input 1	
01 Input Type	Mic, Line +4dBu, Line 0dBV
02 Input Gain	-60dB to -16dB
03 Level	-∞, -120 to +10dB
04 Phantom Power	On, Off
05 Mix to Floor	On, Off
02 MIC/LINE Input 2	
01 Input Type	Mic, Line +4dBu, Line 0dBV
02 Input Gain	-60dB to -16dB
03 Level	-∞, -120 to +10dB
04 Phantom Power	On, Off
05 Mix to Floor	On, Off
03 AUX Input	
01 Level	-∞, -120 to +10dB
02 Mix to Floor	On, Off
04 DU SP Output Lvl	0 - 20
05 VoiceDetectSens	-5, -4, -3, -2, -1, 0, 1, 2, 3, 4, 5, Auto by Mic2 In
[4] Recorder Setting (> page 35)	
01 Rec Format	WAV, MP3
02 RecordingQuality	64, 128, 192, 256, 320kbps
03 No.of Rec CH	1 to 4 (WAV), 1 to 2 (MP3)
04 Rec Source CH1	Floor, Group 0, Group 1, Group 2, Group 3, Language 1, Language 2, Language 3, Sub Mix 1, Sub Mix 2
05 Rec Source CH2	Floor, Group 0, Group 1, Group 2, Group 3, Language 1, Language 2, Language 3, Sub Mix 1, Sub Mix 2
06 Rec Source CH3	Floor, Group 0, Group 1, Group 2, Group 3, Language 1, Language 2, Language 3, Sub Mix 1, Sub Mix 2
07 Rec Source CH4	Floor, Group 0, Group 1, Group 2, Group 3, Language 1, Language 2, Language 3, Sub Mix 1, Sub Mix 2
08 Auto Track	Off, 15, 30 min, 1, 2 hour
09 Filename Prefix	Displays filename prefix
[5] Conference Mode (> page 34)	
01 Conference Mode	Free Talk, Request Talk, Full Remote
02 NOM	1 to 10
03 Auto Mic Off	5 to 60sec ,Off
04 Override Mode	No Override, FIFO, LIFO (depending on Conference Mode)
05 Max Queue	0-150
06 MicON Trigger	All Button, All Voice, Individual
07 MicON Hold Time	1.0 to 10.0 seconds
08 Interrupt Option	Cut, Mute
[6] Logging (> page 37)	
01 Logging	On, Off
02 Destination	Internal, USB
[7] Presets (> page 37)	
01 Recall Presets	Recalls presets
02 Save Presets	Saves presets
03 Import Presets	Imports presets
04 Export Presets	Exports presets

Entering letters

For example, when entering letters from [4] *Recorder Setting* → *09 Filename Prefix*, follow the procedure below.

1 Rotate the jog dial to select a letter.

You can use the following characters.

(1) *Password*

A to Z, a to z, 1 to 9, 0

(2) *Device Name*

A to Z, a to z, 1 to 9, 0, ! " # \$ % & ' () * + , - . / : ; < = > ? @ ` ,
(space)

(3) *Filename Prefix*

A to Z, a to z, 1 to 9, 0, ! # \$ % & ' () + , - . ; = ? @ ` , (space)

2 Press the ENTER button to enter the selected letter.

The cursor moves to the right.

3 Repeat steps 1 and 2 to enter desired text.

To delete characters you have just entered, follow the procedure below.

• To move the cursor to the character you want to edit:

- (1) While pressing and holding the BACK button, rotate the jog dial to move the cursor.
- (2) Release the BACK button.

• To delete characters you have just entered:

- (1) Move the cursor to the character you want to delete.
- (2) While pressing and holding the BACK button, press the ENTER button.

The character at the current cursor position will be deleted.



- When the cursor flashes in “_” state at the end of the text, the character just before the cursor will be deleted.

• To change characters you have just entered:

- (1) Move the cursor to the character you want to edit.
- (2) Rotate the jog dial to select the desired character.

• To finish editing:

- (1) When the cursor is in “■” blinking state, press the ENTER button.

When editing ends, the cursor will move to the end of the text and “_” will blink.

4 To enter the text, when the cursor is in the “_” blinking state, press the ENTER button.

Displays *Completed!* followed by the file name.

System Connections and Configuration

Connecting devices

- NOTICE**
- Do not plug in the supplied AC power cord until all other connections have been completed.
 - Insert the plugs all the way in. Loose connections may cause malfunctions or noise.
 - Check the plug orientations.
 - Refer also to the instruction manuals supplied with the external devices.

Entire system connection diagram (1)

Refer also to the entire system connection diagram (2) (▶ page 19)

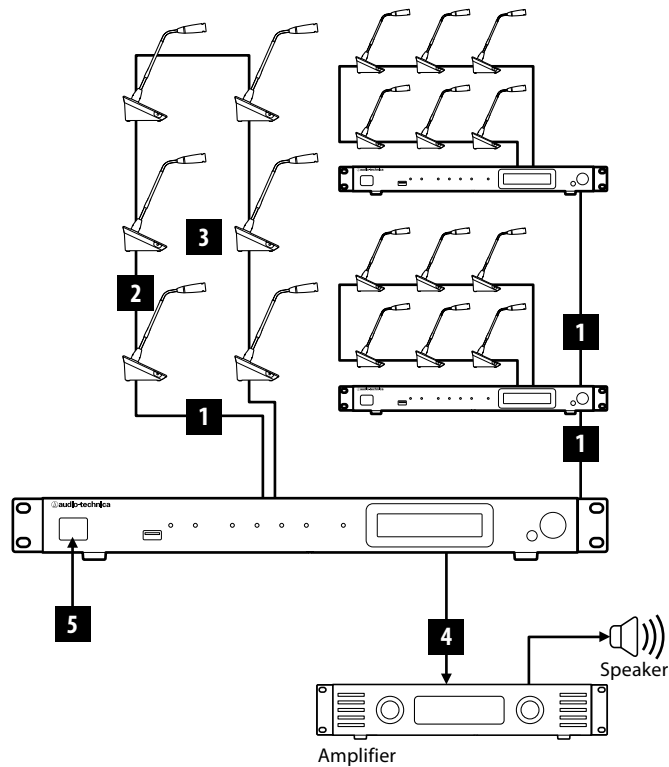

- NOTICE**
- Use CAT5e or higher straight cables. (Shielded cables with conductor size of 24AWG or higher in diameter are recommended.)
 - Using flat type cables or unshielded cables may cause noise and affect other devices.
 - Be sure to establish a ground connection.

When securing a DU to a desk or table, use the screw holes (3 holes) on the bottom side of the DU (screw: M3, P=0.5, within 6mm from the bottom side to the tip of the screw).

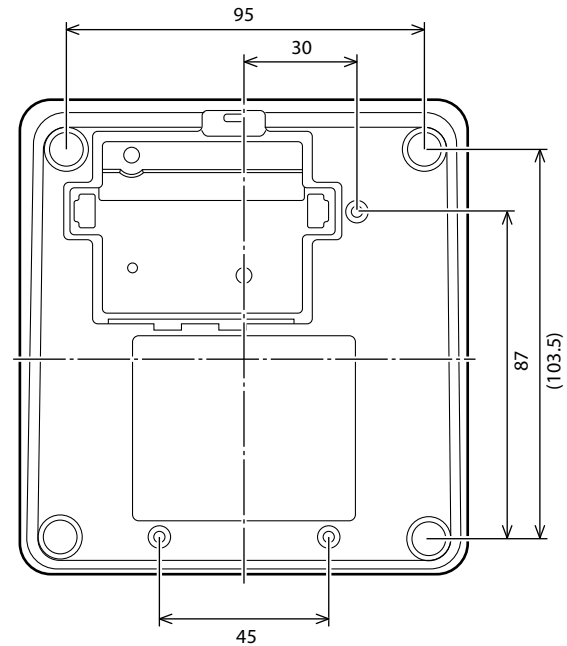

1 Connecting the DUs to the CU

1 Place the CU(s) and DUs.

- NOTICE**
- Place the units on a flat surface or install in a rack. Dropping a unit may cause damage to the unit and/or personal injury.
 - When installing the CU in a rack, read the precautions in advance (▶ page 3).

2 Connect the DU(s) to the DU CHAIN A/B terminal(s).

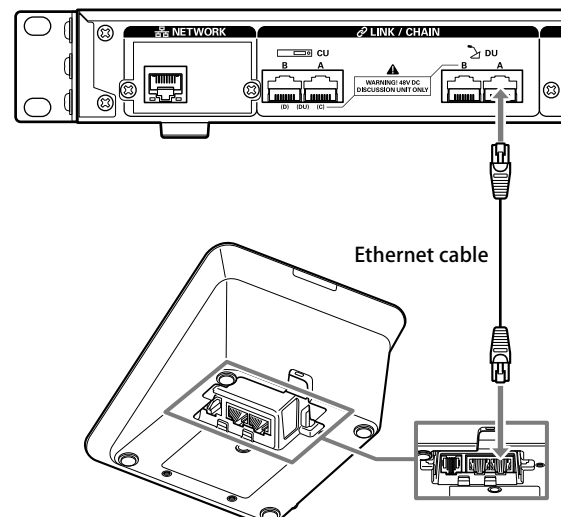

- You can configure the CU LINK A/B terminals as DU CHAIN C/D terminals, and you can also connect DUs in the same manner as the DU CHAIN A/B terminals. However, the maximum number of DUs you can connect to the DU CHAIN C/D terminals is 25 in total. (Note that the maximum number of DUs you can connect to each CU is 50) (▶ page 15).
- Remove the DU bottom cover to connect the Ethernet cables. When removing the bottom cover, pinch together the latches on both sides.
- On the DU, the Ethernet cable may be connected to the left or right DU/CU connection terminal because the DU does not distinguish between DU and CU connection terminals.

2 Connecting the DUs together

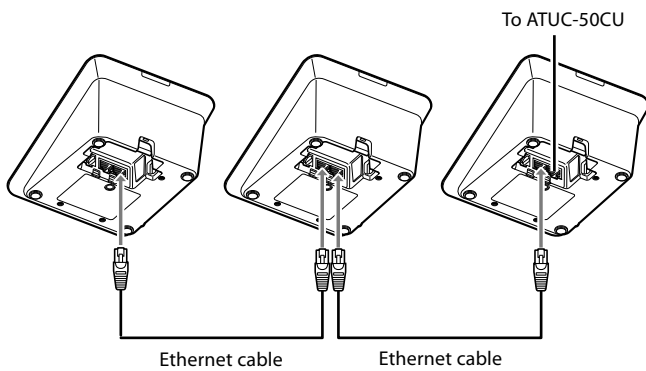

1 Connect the DUs according to the installation environment and operation method.

Daisy-chain connection:

Connect the DUs in a series to the DU CHAIN A/B (C/D) terminals. Compared to ring connection, daisy-chain connection enables the DUs to be placed even farther from the CU.

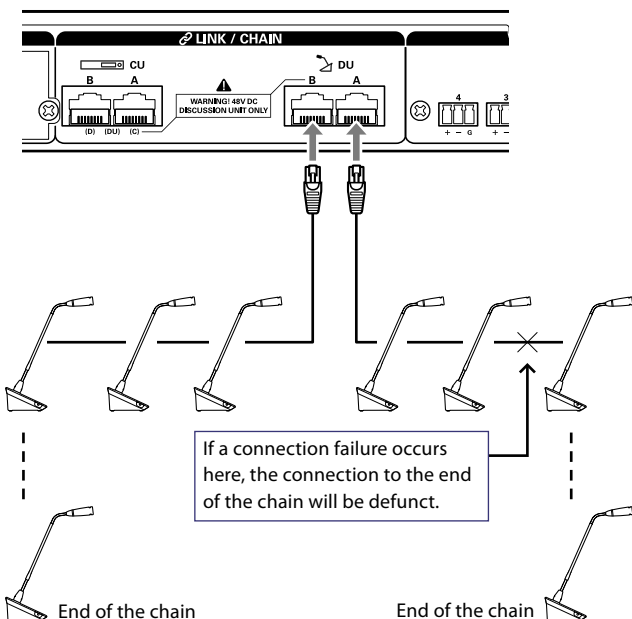

Ring connection:

Connect as many DUs as necessary to each of the DU CHAIN A/B terminals and then connect together the 2 DUs on both ends of the chain so as to form a ring. Even if a connection failure occurs somewhere in the ring, since the connection is recognized as 2 daisy-chains using the DU CHAIN A/B terminals, the influence of the failure can be minimized and you can carry on conference control.

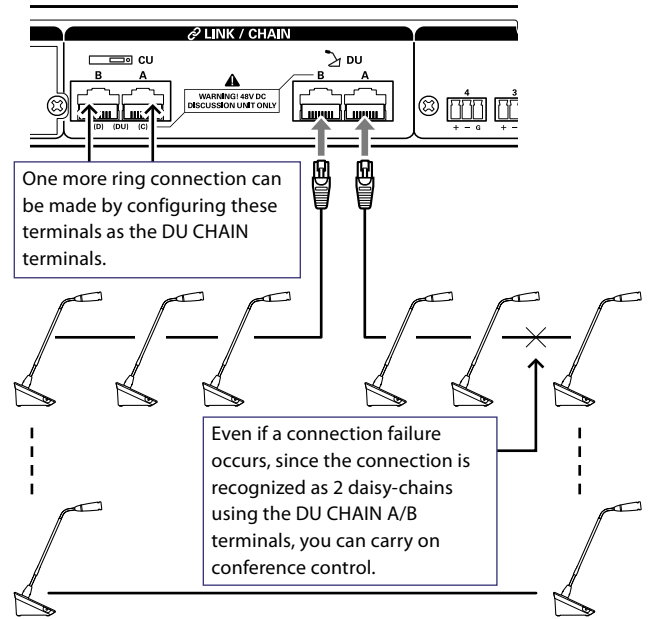

- Combining different connection types is also possible, such as a ring connection using the DU CHAIN A/B terminals and daisy-chain connections using the DU CHAIN C/D terminals.

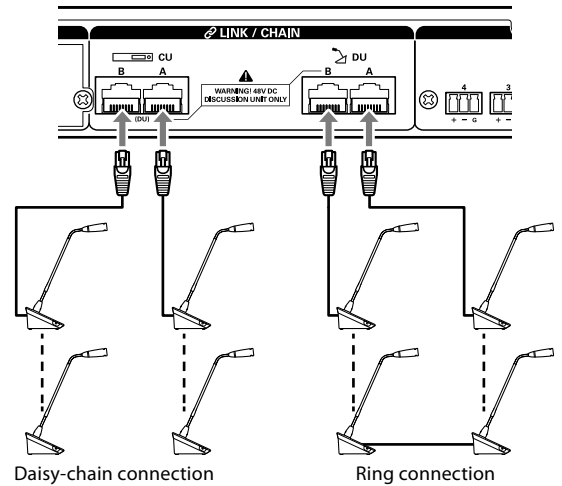

- NOTICE**
- Regardless of the number of DU terminals you use, the maximum number of DUs that can be connected to each CU is 50.
 - Up to 25 DUs can be connected to the DU CHAIN C/D terminals in total. Do not connect 26 or more DUs. Doing so may damage the units.

Relationship between Ethernet cable length and the number of connectable units:

DU-DU	CU-DU	1 port daisy-chain/1 ring connection		2 port daisy-chain connection	
		Number of connectable DUs	Ethernet cable total length	Number of connectable DUs	Ethernet cable total length
1.5m	10m	45Units	76.0m		
1.5m	30m	40Units	88.5m		
1.5m	50m	36Units	102.5m		
1.5m	100m	24Units	134.5m		
2.0m	10m	43Units	94.0m		
2.0m	30m	39Units	106.0m		
2.0m	50m	34Units	116.0m		
2.0m	100m	24Units	146.0m		
3.0m	10m	40Units	127.0m	25 × 2Unit	82.0m × 2
3.0m	30m	36Units	135.0m	24 × 2Unit	99.0m × 2
3.0m	50m	31Units	140.0m	23 × 2Unit	116.0m × 2
3.0m	100m	22Units	163.0m	20 × 2Unit	157.0m × 2
5.0m	10m	33Units	170.0m	24 × 2Unit	125.0m × 2
5.0m	30m	29Units	170.0m	23 × 2Unit	140.0m × 2
5.0m	50m	27Units	180.0m	22 × 2Unit	155.0m × 2
5.0m	100m	20Units	195.0m	19 × 2Unit	190.0m × 2

DU-DU	CU-DU	4 port daisy-chain connection		2 ring connections	
		Number of connectable DUs	Ethernet cable total length	Number of connectable DUs	Ethernet cable total length
1.5m	10m	A/B: 15 × 2Units C/D: 10 × 2Units	A/B: 31m × 2 C/D: 23.5m × 2	A-B: 25Units C-D: 25Units	A-B: 46m C-D: 46m
1.5m	30m	A/B: 15 × 2Units C/D: 10 × 2Units	A/B: 51m × 2 C/D: 43.5m × 2	A-B: 25Units C-D: 25Units	A-B: 66m C-D: 66m
1.5m	50m	A/B: 15 × 2Units C/D: 10 × 2Units	A/B: 71m × 2 C/D: 63.5m × 2	A-B: 23Units C-D: 23Units	A-B: 83m C-D: 83m
1.5m	100m	A/B: 14 × 2Units C/D: 10 × 2Units	A/B: 119.5m × 2 C/D: 113.5m × 2	A-B: 20Units C-D: 20Units	A-B: 128.5m C-D: 128.5m
2.0m	10m	A/B: 15 × 2Units C/D: 10 × 2Units	A/B: 38m × 2 C/D: 28m × 2	A-B: 25Units C-D: 25Units	A-B: 58m C-D: 58m
2.0m	30m	A/B: 15 × 2Units C/D: 10 × 2Units	A/B: 58m × 2 C/D: 48m × 2	A-B: 25Units C-D: 24Units	A-B: 78m C-D: 76m
2.0m	50m	A/B: 15 × 2Units C/D: 10 × 2Units	A/B: 78m × 2 C/D: 68m × 2	A-B: 23Units C-D: 23Units	A-B: 94m C-D: 94m
2.0m	100m	A/B: 14 × 2Units C/D: 10 × 2Units	A/B: 126m × 2 C/D: 118m × 2	A-B: 20Units C-D: 20Units	A-B: 138m C-D: 138m
3.0m	10m	A/B: 15 × 2Units C/D: 10 × 2Units	A/B: 52m × 2 C/D: 37m × 2	A-B: 25Units C-D: 25Units	A-B: 82m C-D: 82m
3.0m	30m	A/B: 15 × 2Units C/D: 10 × 2Units	A/B: 72m × 2 C/D: 57m × 2	A-B: 24Units C-D: 24Units	A-B: 99m C-D: 99m
3.0m	50m	A/B: 15 × 2Units C/D: 10 × 2Units	A/B: 92m × 2 C/D: 77m × 2	A-B: 23Units C-D: 22Units	A-B: 116m C-D: 113m
3.0m	100m	A/B: 14 × 2Units C/D: 10 × 2Units	A/B: 139m × 2 C/D: 127m × 2	A-B: 20Units C-D: 19Units	A-B: 157m C-D: 154m
5.0m	10m	A/B: 15 × 2Units C/D: 10 × 2Units	A/B: 80m × 2 C/D: 55m × 2	A-B: 24Units C-D: 24Units	A-B: 125m C-D: 125m
5.0m	30m	A/B: 15 × 2Units C/D: 10 × 2Units	A/B: 100m × 2 C/D: 75m × 2	A-B: 23Units C-D: 23Units	A-B: 140m C-D: 140m

DU-DU	CU-DU	4 port daisy-chain connection		2 ring connections	
		Number of connectable DUs	Ethernet cable total length	Number of connectable DUs	Ethernet cable total length
5.0m	50m	A/B: 15 × 2Units C/D: 10 × 2Units	A/B: 120m × 2 C/D: 95m × 2	A-B: 22Units C-D: 22Units	A-B: 155m C-D: 155m
5.0m	100m	A/B: 14 × 2Units C/D: 9 × 2Units	A/B: 165m × 2 C/D: 140m × 2	A-B: 19Units C-D: 18Units	A-B: 190m C-D: 185m

The values in the tables above are calculated based on the following assumptions.

- The number of connectable DUs and total cable length are calculated based on the assumption that the ATUC-M is connected to each DU.
- Use CAT5e or higher cables. (A shielded cable with conductor size of 24AWG or higher in diameter is recommended.)
- 1-port daisy-chain/1 ring connection: Daisy-chain DUs to either the DU CHAIN A or B terminal or make a ring connection using the DU CHAIN A-B terminals.
- 2-port daisy-chain connection: Daisy-chain the same number of DUs to the DU CHAIN A and B terminals.
- 4-port daisy-chain connection: Daisy-chain the same number of DUs to the DU CHAIN A and B terminals and daisy-chain the same number of DUs to the DU CHAIN C and D terminals.
- 2-ring connections: Make one ring connection using the DU CHAIN A-B terminals and make the other ring connection using the DU CHAIN C-D terminals.
- When making a ring connection with the DU CHAIN A-B terminals, the relationship between Ethernet cable length and number of connectable DUs is the same as that of 1-port daisy-chain connection.
- When you need more distance between the DUs, the 2-port daisy-chain connection allows you to connect more DUs than the 1-port daisy-chain connection.

- NOTICE**
- When connecting DUs, never exceed the number of connectable DUs and the connectable length (total length and distance between each unit). This may cause a malfunction.
 - You can also connect the DUs to the CU LINK terminals by configuring as DU CHAIN C/D terminals. However, if the number of the DUs connected to the DU CHAIN A/B terminals have not reached the maximum, be sure to connect DUs to the DU CHAIN A/B terminals.
 - Up to 25 DUs can be connected to the DU CHAIN C/D terminals in total. Connecting 26 or more DUs may damage the units.
 - The combinations shown above are representative examples. For other combinations, please inquire with our sales representative.

CU Link connection:

Up to 3 CUs can be cascaded (cascade CUs using the CU LINK A/B terminals as shown below). Set one of the CUs as the primary unit.

Since up to 50 DUs can be connected to each CU, if you use 3 CUs, up to 150 DUs can be connected in total.

Follow the procedure below to cascade CUs.

- ① Connect the CU LINK A terminal on the 1st extension CU to the CU LINK B terminal on the primary CU.
- ② When cascading 2 extension CUs, connect the CU LINK A terminal on the 2nd extension CU to the CU LINK B terminal on the 1st extension CU.

Primary CU

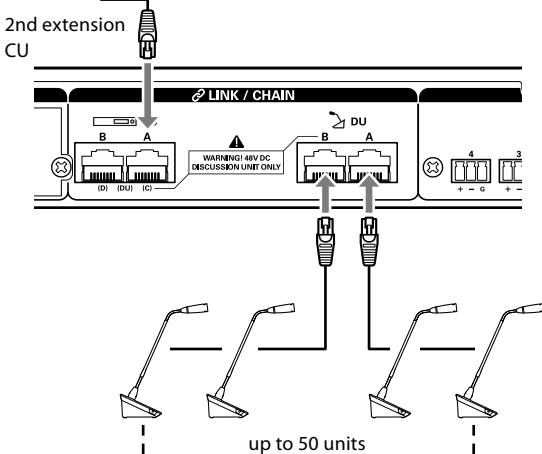
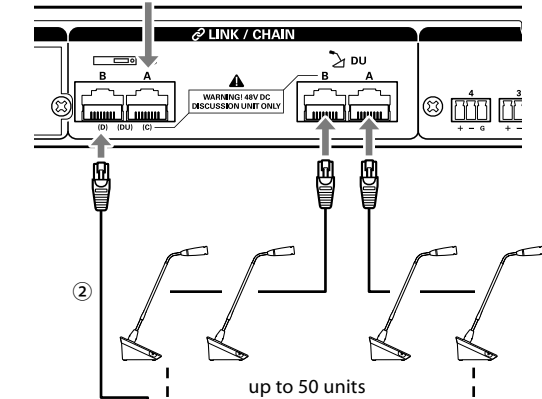
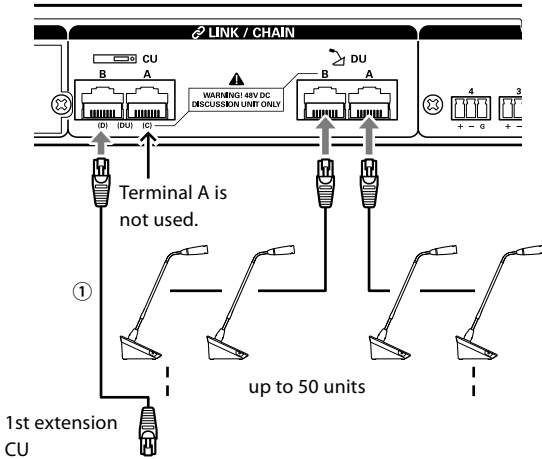

Primary/Extension (CU Link Mode):

	Primary CU	1st extension CU	2nd extension CU
2-CU Link	[Primary]	[Extension 2]	-
3-CU Link	[Primary]	[Extension 1]	[Extension 2]

- You can either daisy-chain (➔ page 14) or ring (➔ page 14) DUs to each CU.

- NOTICE**
- When using only one CU without a CU Link connection, be sure to set [CU Link Setting] to [Primary]. If [CU Link Setting] is set to [Extension], we do not assume responsibility for any unexpected consequences that may occur.

2 Attach the bottom cover to the DU.

After connecting the Ethernet cables to the DUs, attach the bottom cover to each DU.

- The Ethernet cable is fixed securely between the DU and the bottom cover. This helps reduce the weight of the DU which bears on the Ethernet cables.
- To lead the cable out to the rear side, use the through hole ①. To lead the cable out to the bottom side, use the through holes ②.

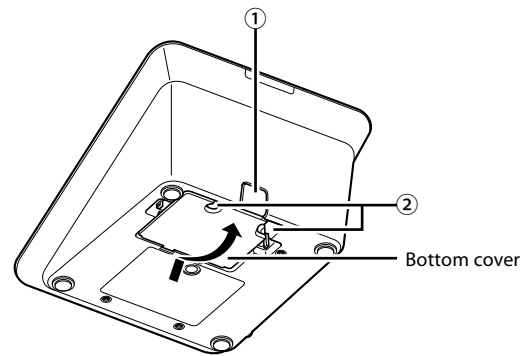

3 Attach the optional bottom weight to the DUs.

- When using DUs that are not secured to desktops or tabletops, it is recommended to use the optional bottom weight (330g) for secure placement.
- To purchase the optional accessories, contact our sales team.

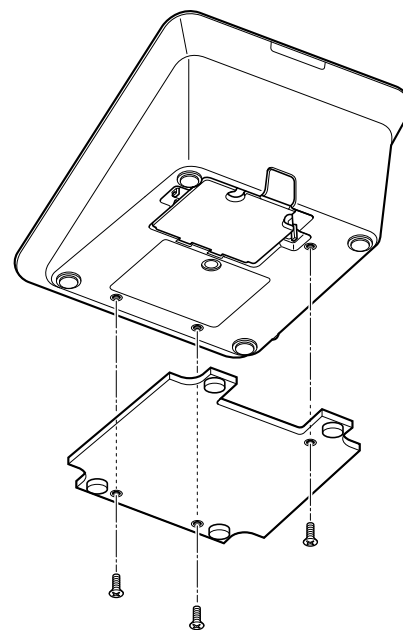

3 Connecting the microphone ATUC-M to the DU

1 Connect the ATUC-M to the microphone jack on the DU.

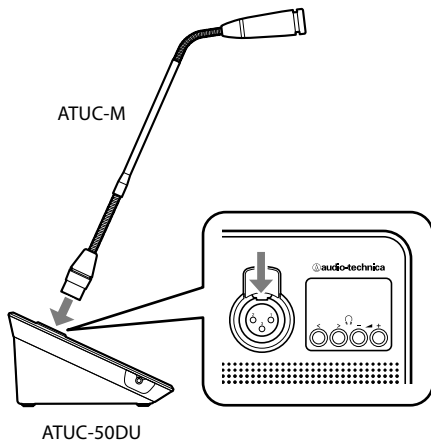

- NOTICE**
- Insert the ATUC-M connector in until you hear a clicking sound.
 - Do not attempt to lift up the DU by grabbing onto the ATUC-M. Be sure to hold the main body of the DU when lifting it up.
 - Slowly bend or extend the flexible part of the ATUC-M. Do not apply excessive force to the ATUC-M when bending it.
 - When disconnecting the ATUC-M from the DU, securely hold the connector while pressing down the microphone release lever and then remove the ATUC-M.
 - Before connecting/disconnecting the ATUC-M, be sure to turn off the power. If you do not turn off the power, malfunction may occur.

4 Connecting an amplifier

1 Connect an amplifier to the OUTPUT BAL. terminal.

Connect an amplifier to amplify sound.
Connect a speaker via the amplifier.

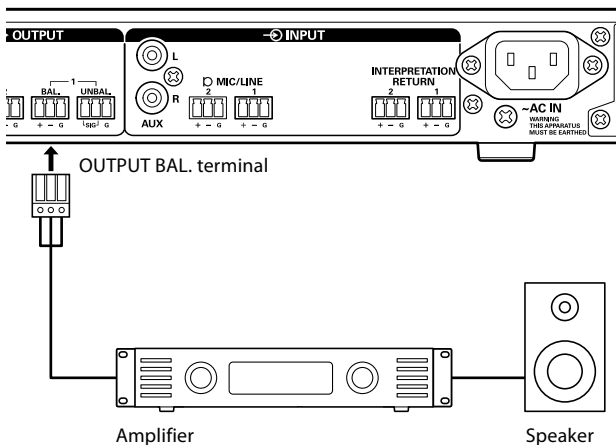

- NOTICE**
- When connecting external devices, refer also to the instruction manuals supplied with them.

5 Turning on the CU and testing DU operations

After checking that all the connections from steps **1** to **4** have been done properly, follow the procedure below to turn on the power of the CU.

1 Check that all the PA devices such as an amplifier and mixer are off.

2 Connect the supplied AC power cord to the CU.

- NOTICE**
- Be sure to use the supplied AC power cord. Using an AC power cord other than the supplied one may cause problems such as damage to the CU, which can be very dangerous.
 - Be sure to connect the AC power cord into a properly grounded wall outlet. Improper grounding can cause electrical shock.
 - Be sure that the CU is securely grounded to a single ground point. Grounding to multiple ground points can cause ground loops, resulting in noise generation such as a humming noise

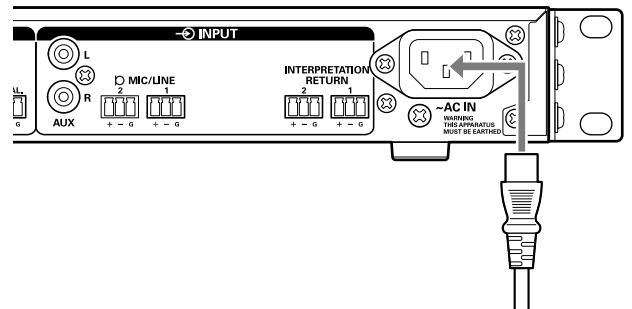

3 Press the power button.

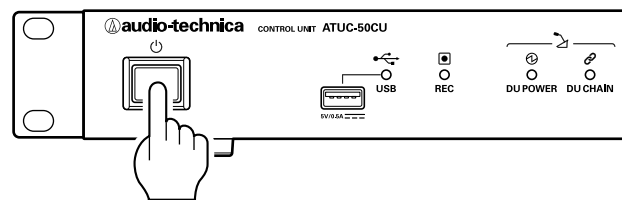

- NOTICE**
- When one or two extension CUs are connected to the system, turn on the power of the primary CU and extension CU(s) at the same time. If the time period between each power-on time is significantly long, a successful CU Link may not be established.

-  • Configure the network setting from the CU (▶ page 11) as necessary.

4 After the CU starts up, press the (talk) button of each DU to confirm operation.

NOTICE • When the DUs are placed close to each other, excessively raising the volume of the DU speakers may cause howling. In such a case, move the DUs farther away from each other or decrease the volume.

5 After checking that the DUs are operating, turn off the CU before proceeding to the next step for connecting the CU to a network device.

NOTICE • If the power of the amplifier is on, first turn off the power of the amplifier.

Entire system connection diagram (2)

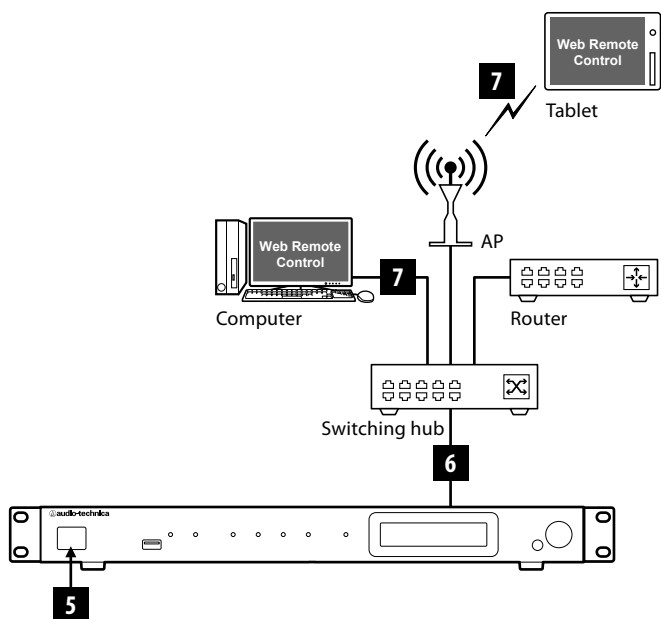

6 Connecting to a network

Configure the detailed conference system settings via Web Remote by connecting the CU to a network (▶ page 21).

1 Use an Ethernet cable to connect the CU to a switching hub via the NETWORK terminal.

NOTICE • Be careful NOT to connect the Ethernet cable from your network device to the CU LINK terminal or DU CHAIN terminal. This can cause damage to the connected device.

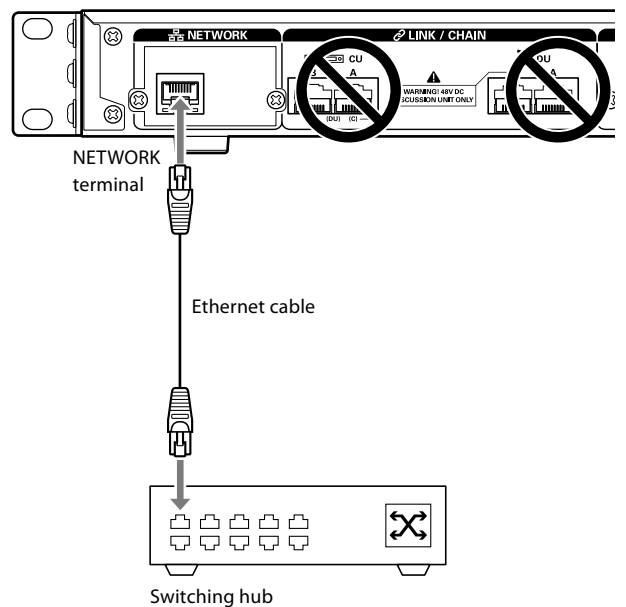

7 Connecting a computer or mobile device to a network

About network settings

- If there is a DHCP server running on the network, the CU automatically configures network settings including the IP address.
- If there is no DHCP server running on the network, manually configure network settings including the IP address from the Set Menu → *System Setting* (▶ page 7).
- When configuring settings manually, inquire with the network manager regarding setting items.

NOTICE • We decline any and all responsibility for communication errors and failures regarding your network environment and external devices.

- Disable the firewall setting on your computer. Otherwise, "Locate" will not recognize the CU.

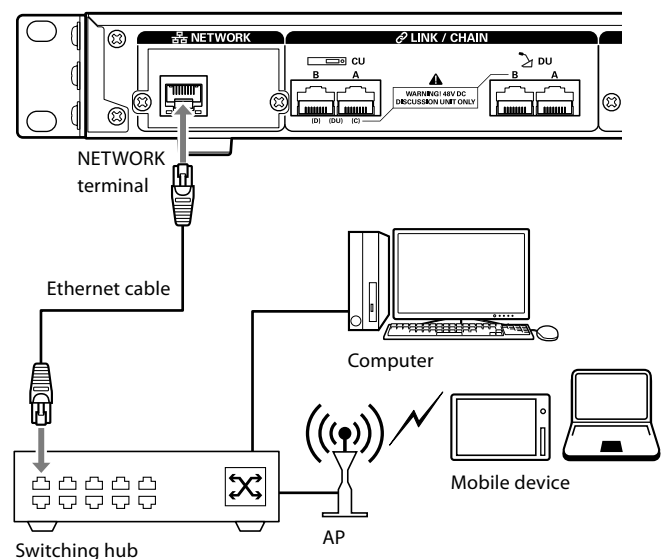

To connect the CU directly to the your Windows PC/Mac using an Ethernet cable

If your computer is equipped with an NIC (Network Interface Card), you can also connect the CU directly to the computer using an Ethernet cable.

NOTICE • Be careful NOT to connect the Ethernet cable from the computer to the CU LINK terminal or DU CHAIN terminal. This can cause damage to the computer.

- 1 Connect an Ethernet cable (straight) to the NETWORK terminal on the CU and Ethernet terminal on a computer.**
- 2 In the network settings on your Windows PC/Mac, select “Obtain an IP address automatically” on your Windows PC, or “Using DHCP” on your Mac, and then save the settings.**
- 3 Start up the CU and from the Set Menu → *System Info* → *IP Config Mode*, select *Auto* (▶ page 7).**
- 4 Press the BACK button to close the Set Menu.**



• After changing the network setting item(s), restart the CU to enable the setting values.

Since there is no DHCP server, an IP address is automatically assigned to the Windows PC/Mac and the CU using the APIPA (Automatic Private IP Addressing) feature.

Preparing to use Web Remote

What is Web Remote?

Web Remote is a web application to control this system.

Using Web Remote enables you to remotely perform the following operations from a computer or mobile device (hereinafter, control device):

- Preparing for conferences
- Operating and controlling conferences
- Configuring detailed settings

After connecting the CU to the control device, download “Locate”. Using “Locate” enables you to simply access Web Remote (▶ page 23) without typing the IP address of the ATUC-50CU installed.



- You can also start up Web Remote without using “Locate” (▶ page 23).

Operating Environment for Web Remote and “Locate”

- Microsoft Windows 7 or later
- Apple OS X 10.10 Yosemite or later
- Android OS 4.4 or later
- iOS 8 or later

Recommended web browser for Web Remote

- Google Chrome ver. 49 or later (Windows and Android)
- Mozilla Firefox ver. 45 or later (Windows)
- Safari 9.0 or later (OS X and iOS)

NOTICE • Up to 3 control devices can simultaneously log in to Web Remote.

When 2 web browsers are running on a control device, Web Remote counts the web browsers as 2 separate devices.

- When you have finished with Web Remote, be sure to log out of Web Remote before closing the web browser window.

If you simply close the window without logging out, you will remain logged in to Web Remote for 5 minutes until the session times out.

Setting up “Locate”

1 Download the “Locate” installer onto the control device.

For Windows/Mac users:

Download the “Locate” installer that applies to your country/region from the Audio-Technica website:

http://www.audio-technica.com/world_map/

Proceed to step 2.

For iOS users:

Search from App Store and install “Locate”.



Proceed to step 4.

For Android users:

Search from Google Play and install “Locate”.



Proceed to step 4.

2 Double-click “setup.exe” downloaded.

The setup wizard will appear.

3 Follow the on-screen instructions to install “Locate” onto the control device.

After the installation is complete, the “Locate” icon will appear on the desktop.

4 Check that the ATUC-50CU and the control device are connected to the same network, and that the power of the CU is ON, then double-click the “Locate” icon.

“Locate” will start up. ATUC-50CU connected to the network will be detected automatically.

5 Select the CU you want to control via Web Remote, then click [Open].

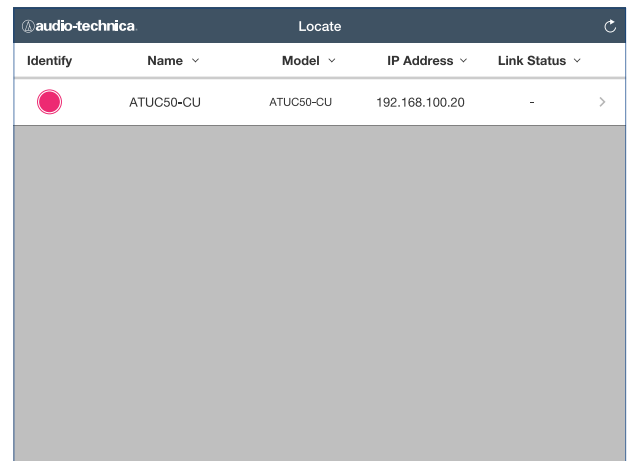

The Web Remote login screen appears.



- When the [Identify] icon is clicked, the icon lights red and the indicators blink on the front panel of the selected CU. This function is useful if there are multiple CUs in the system and you want to identify a CU such as when you select the CU you want to control from the CUs displayed in the “Locate” list.

Configuring and Operating Conferences Using the Web Remote Control Function

About Web Remote

Overall structure of Web Remote

From the Home screen below, you can access the 3 main menus.

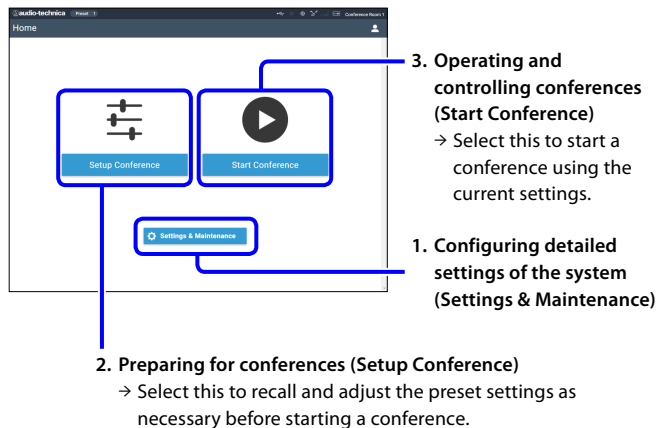

1. Configuring detailed settings of the system (Settings & Maintenance) (▶ page 24):

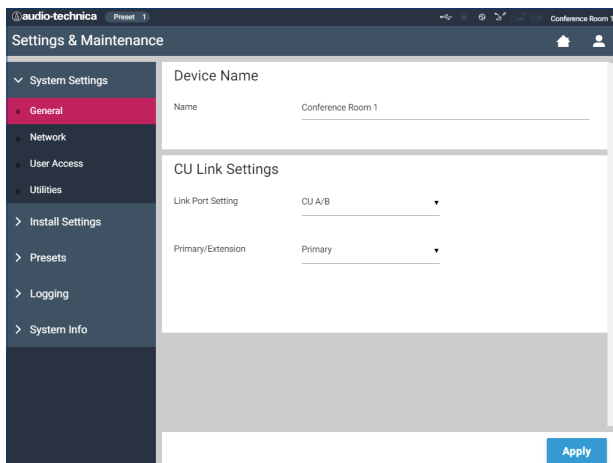

Under [Settings & Maintenance], the following 5 sub-menus are available for configuring detailed settings of the entire system.

[System Settings] (▶ page 25)

Allows you to set the unit name and a login password as well as access authority setting, and configures network-related settings.

You can also update the firmware from here.

[Install Settings] (▶ page 29)

Allows you to select conference mode (▶ page 34).

You can also configure advanced CU audio input/output settings and recording settings.

Furthermore, you can configure DU detail settings such as speaker volume and LED color for each DU.

[Presets] (▶ page 37)

Allows you to preset settings configured from [Install Settings] and recall the settings. You can also export the desired preset setting and import it to another ATUC-50.

[Logging] (▶ page 37)

Allows you to turn the logging function on/off and download a log file.

[System Info] (▶ page 37)

Displays the network setting information and firmware version.

2. Preparing for conferences (Setup Conference) (▶ page 38):

Follow the 3 steps below to prepare for a conference.

[Recall Preset] (▶ page 38)

Select the desired preset conference setting according to the upcoming conference.

To handle many different types of conferences using 1 ATUC-50 system, it is recommended to preset multiple types of conference settings.

[Conference Settings] (▶ page 38)

According to the upcoming conference, set the [Conference Mode] (▶ page 34), which defines the talk method, and then configure the detailed settings.

[DU Settings] (▶ page 39)

For each DU connected to the system, set the attendee name and configure the audio settings and priority setting.

3. Operating and controlling conferences (Start Conference) (▶ page 40):

Operate and control the conference by switching the screen among the following 3 screens.

[Conference Manager] (▶ page 40)

Displays an attendee (DU) list. The list shows information including the attendee names, priority setting status and talk request status. Furthermore, you can permit the attendees to talk.

[Audio Control] (▶ page 41)

Configure the primary output settings and perform audio-related operations such as buzzer playback and conference recording operations.

[Conference Settings] (▶ page 41)

You can change detailed settings such as conference mode even during the conference.

Starting up Web Remote and preparing for operations

This chapter explains the Web Remote startup operation and the header always displayed on the top of the screen.

Starting up and logging in to Web Remote

1 Display the Web Remote login screen.

To log in to Web Remote from “Locate”:

- Follow steps 4 to 5 in “Setting up ‘Locate’” (▶ page 21). Web Remote starts up and the login screen appears.

To log in to Web Remote without using “Locate”:

NOTICE • Check that the CU is connected to the same network as the control device. When using a control device with a network terminal, you can also directly connect the CU to the control device using an Ethernet cable (▶ page 20).

- From the CU Set Menu → *System Info* → *IP Address*, check the IP address of the CU (▶ page 7).
- Run the browser and type the IP address you checked in step (1) in the address bar. Web Remote starts up and the login screen appears.

2 Select [Operator] or [Administrator], then click [Login].

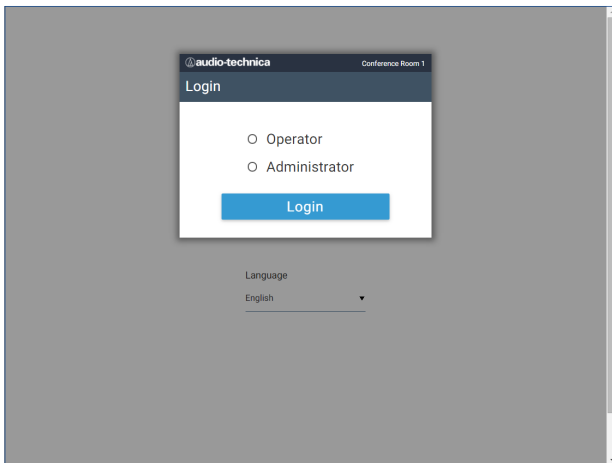

To change the language, click [▼] next to the language display to expand the drop-down list and select the desired language.

The [Operator] access authority can be set from [System Settings] → [User Access] → [Operator Access Settings] (▶ page 26).

When a login password (▶ page 26) is already set, enter the password on the password input screen.

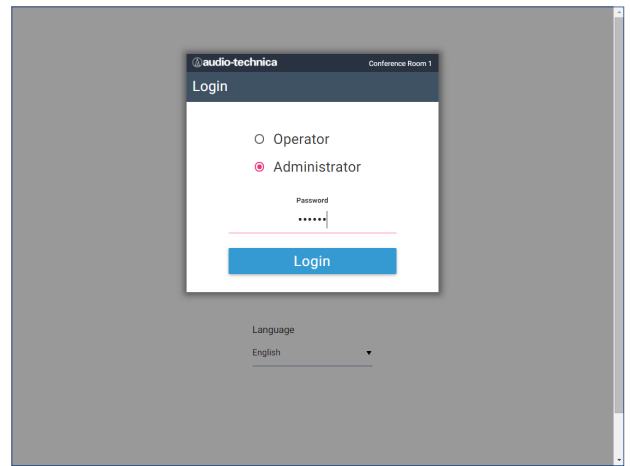

After successfully logging in to Web Remote, the Home screen appears.

About Web Remote Home screen

- Depending on the [Operator] access authority setting, [Settings & Maintenance] may not appear on the Home screen.

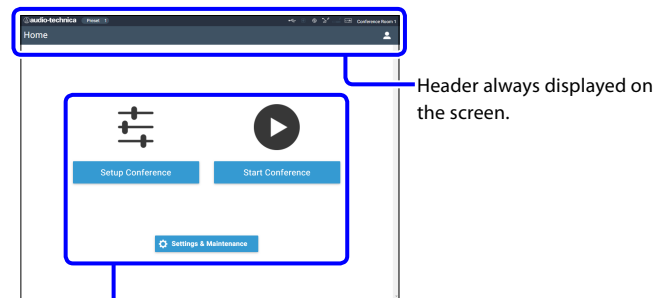

Access each screen (▶ page 24).

About the display items on the header:

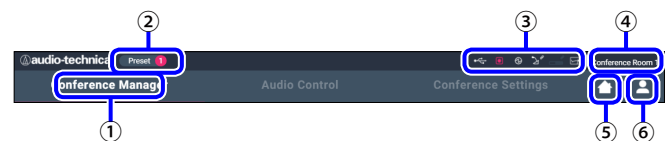

- Displays the screen name (e.g. Home).
- Displays the recalled preset conference number (▶ page 37). If some changes have been applied to the recalled preset, the preset number will appear in white color in a circle with a red background.
- Displays various indicators (▶ page 6). If any problem occurs, “▲” appears below the corresponding indicator. Placing the cursor over the indicator will display the pop-up screen which shows the details of the problem.
- Displays the name of the unit such as ATUC-50CU which is being controlled via Web Remote.
- Home button: Click to return to the Home screen.
- Logout button: Click to display the currently logged-in authority and the logout menu.

■ Configuring detailed system settings ([Settings & Maintenance])

From this menu, detailed system settings can be configured. Utilities for troubleshooting and maintenance are also available.

How to operate the [Settings & Maintenance] menu

- 1 On the Web Remote Home screen, click [Settings & Maintenance].

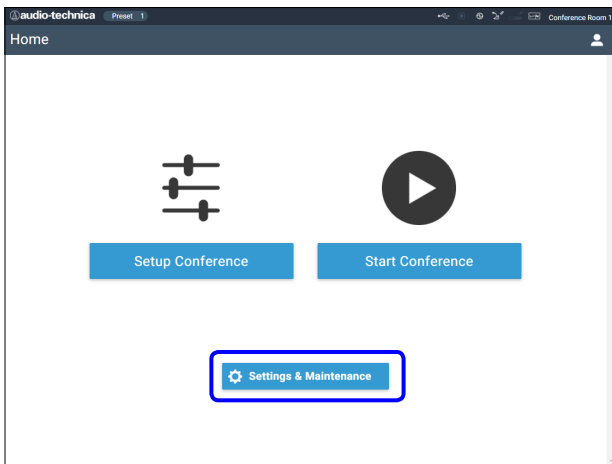

- 2 From the 5 menu items on the left, click the item you want to configure.

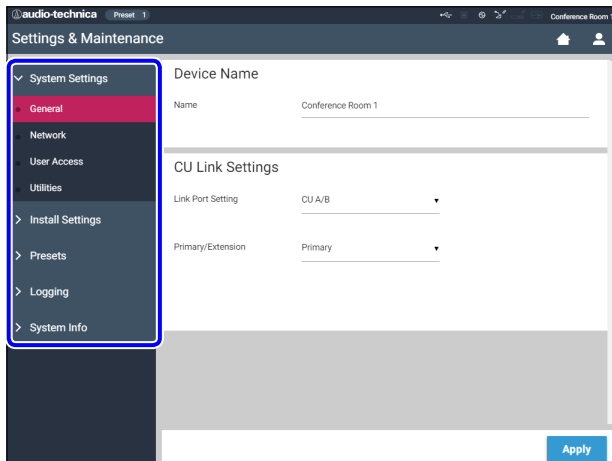

- 3 Change the settings as necessary, then click [Apply].

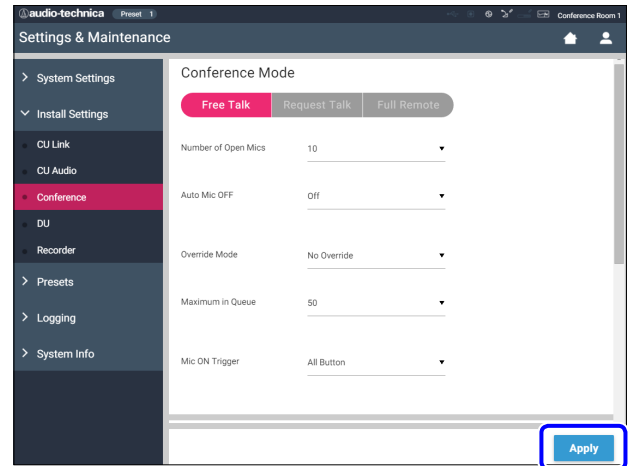

- The buttons displayed may vary depending on the screen.
- On screens where value changes are immediately applied, such as on audio-related setting screens, the [Apply] button may not appear.

Menu item ① ([System Settings])

The setting values and default setting of each item which you can set from [System Settings] are as follows.

The item names with **CU** on the left are the names displayed on the CU display.

Items with **P** are included in the preset settings.











General Settings ([General])

Item name	Description and setting values (default settings are shown in bold)
Device Name	
CU Name	Displays the name of the unit being controlled via Web Remote. ATUC-50CU
CU Link Settings	
CU Link Port Setting CU Link Port Set	Switch the terminal setting between CU LINK A/B terminals and DU CHAIN C/D terminals. CU A/B, DU C/D
CU Primary/Extension CU CU Link Mode	Set the dependency relationship of each CU (Primary/Extension) when multiple CUs are cascade-connected. Primary, Extension 1, Extension 2 NOTICE • When using only one CU without a CU Link connection, be sure to set [CU Link Setting] to [Primary]. If [CU Link Setting] is set to [Extension], we do not assume responsibility for any unexpected consequences that may occur.





Network Settings ([Network])

 • After changing the network setting item(s), restart the CU to enable the setting values.

Item name	Description and setting values (default settings are shown in bold)
IP Settings	
IP Config Mode	Specify the IP address-acquiring method. Auto: IP address is assigned by a DHCP server or the like. Static: Specify static IP address. This enables you to specify the IP address, subnet mask, and gateway address.
IP Address	Displays the IP address. Does not display when [IP Config Mode] is set to [Auto].
Subnet Mask	Displays the subnet mask. Does not display when [IP Config Mode] is set to [Auto].
Gateway Address	Displays the gateway address. Does not display when [IP Config Mode] is set to [Auto].
Allow Discovery	Enable/disable automatic detection from "Locate". On, Off
IP Control Settings	
CU Port Number CU IP Ctrl Port No	Displays the IP control port number. 00001-65535 (17300)
CU Notification CU IP Ctrl Ntfy	Enable/disable notification from the device during IP control. On, Off
CU Audio Level Notification CU Audio Level Ntfy	Enable/disable notification of the audio level from the device when IP control is enabled. On, Off
CU Multicast Address CU M-cast Adrs	Specify multicast address. 0.0.0.0 - 255.255.255.255 (225.0.0.100)
CU Multicast Port Number CU M-cast Port No	Specify multicast port number. 00001-65535 (17000)

Auto Mode Change When Network Connection Lost	
Enabled  Auto Mode Change	Automatically switches the conference mode to [Free Talk] Mode when a network error occurs while operating in [Full Remote] Mode. On, Off
Hold time  Hold Time (Err)	Set the time interval until [Full Remote] Mode switches to [Free Talk] Mode after a network error occurs. 20, 30, 40 sec  • During Web Remote control, the time interval may be longer by up to 15 seconds.
NTP Settings	
Enabled  NTP	Enable/disable NTP (Network Time Protocol). On, Off
Server Address  NTP Adrs	Specify the NTP sever address. 0.0.0.0 - 255.255.255.255 (Empty)
Port Number  NTP Port	Specify the NTP port number. 00001-65535 (123)
Time Zone	Specify the time difference to UTC (Coordinated Universal Time). UTC -12:00 to +14:00; in 0:30 minute increments (00:00)
Daylight Saving Time  DST	Enable/disable the daylight saving time option. On, Off
Start Date  DST Start Date	Specify the month and day you want to activate the daylight saving time option. mm/dd: 1/1-12/31 (3/27)
Start Time  DST Start Time	Specify the time you want to activate the daylight saving time option. 0:00-23:00; in 1 hour increments (2:00)
End Date  DST End Date	Specify the month and day you want to deactivate the daylight saving time option. mm/dd: 1/1-12/31 (10/30)
End Time  DST End Time	Specify the time you want to deactivate the daylight saving time option. 0:00-23:00; in 1 hour increments (2:00)

User Access Settings ([User Access])

Item name	Description and setting values (default settings are shown in bold)
Login Password	
Administrator Password  Admin.Pwd.Login	Enable/disable login password requirement for Administrator. On, Off
 Admin.Password	Set a login password for Administrator. 4 to 8 alphanumeric characters (Empty)
Operator Password  Opr.Pwd.Login	Enable/disable login password requirement for Operator. On, Off
 Opr.Password	Set a login password for Operator. 4 to 8 alphanumeric characters (Empty)
Operator Access Settings	
Configure settings of access authority granted to Operator.	
Home Page	
Start Conference Setup Conference	Enable/disable function limitation for conference preparation ([Setup Conference]) and conference operation and control ([Start Conference]). Full, Limited
Settings & Maintenance	Allow/restrict access to detailed settings ([Settings & Maintenance]). When this item is set to [No], the [Settings & Maintenance] button will not appear on the Home screen. Yes, No

Settings & Maintenance	Enable/disable access authority for detailed setting of each item ([Settings & Maintenance] on Web Remote, <i>Set</i> on the CU display).
CU Display Menu	
Install Settings	
CU Audio Setting, Recorder Setting	Yes, No
Presets	Yes, No
Logging	Yes, No
System Info	Yes, No

Utilities ([Utilities])

The following operations can be performed from [System Settings].

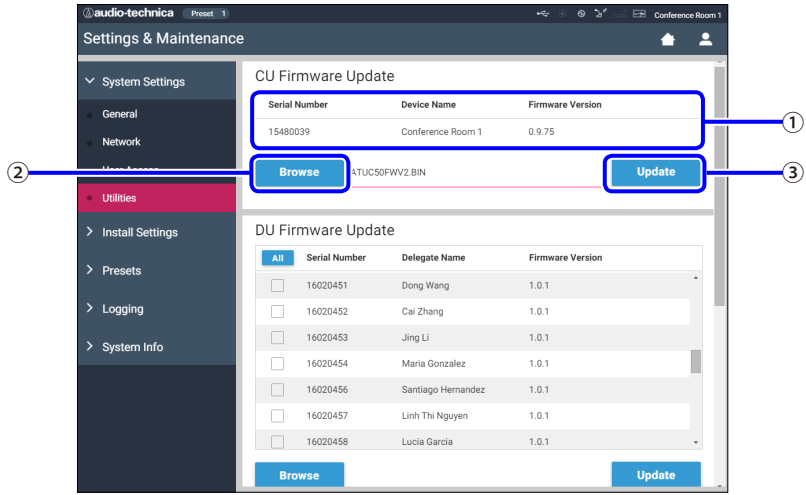
Item name	Description and operation procedure						
CU Firmware Update	<p>Updates the CU firmware.</p>  <p>The screenshot shows the 'CU Firmware Update' screen. A table displays the following information:</p> <table border="1"> <thead> <tr> <th>Serial Number</th> <th>Device Name</th> <th>Firmware Version</th> </tr> </thead> <tbody> <tr> <td>15480039</td> <td>Conference Room 1</td> <td>0.9.75</td> </tr> </tbody> </table> <p>Below the table, there is a 'Browse' button and an 'Update' button. A 'DU Firmware Update' section is also visible below, containing a table with columns for Serial Number, Delegate Name, and Firmware Version. The 'DU Firmware Update' table lists several devices with their respective serial numbers and delegate names.</p> <ol style="list-style-type: none"> Check the [Serial Number], [Device Name], and the current [Firmware Version] on the screen to be sure that the displayed CU is the one you want to update. Click [Browse] to display the file select screen and select the version upgrade file. Click [Open] to start loading the file. When the loading is complete, [Update] will be selectable. Click [Update]. After the confirmation message appears on the pop-up screen, click [Yes] to perform the update. When the update is complete, [Completed. Device will automatically reboot momentarily.] will appear and the CU will automatically restart in 3 seconds. 	Serial Number	Device Name	Firmware Version	15480039	Conference Room 1	0.9.75
Serial Number	Device Name	Firmware Version					
15480039	Conference Room 1	0.9.75					

Updates the DU firmware.

DU Firmware Update

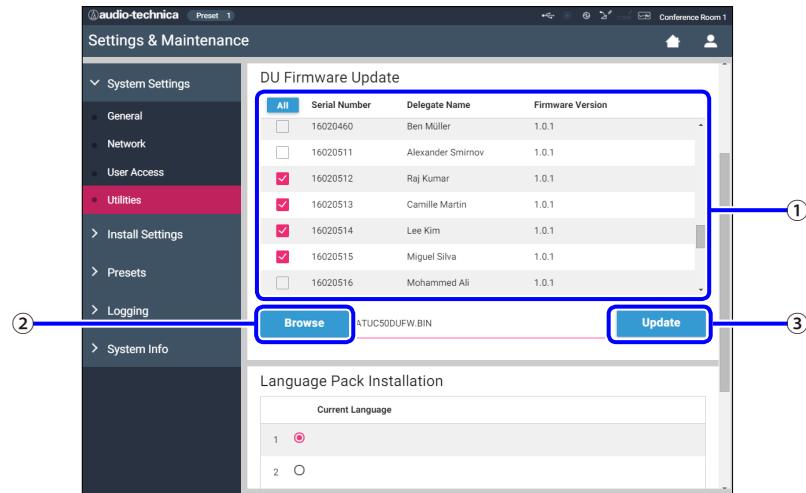

- ① Click the checkbox next to the [Serial Number], [Delegate Name], and the current [Firmware Version] of each DU you want to update.
When you want to select all DUs, click [All] on the upper left of the DU Firmware Update section on the screen.
- ② Click [Browse] to display the file select screen and select the version upgrade file.
Click [Open] to start loading the file.
- ③ When the loading is complete, [Update] will be selectable. Click [Update].
- ④ After the confirmation message appears on the pop-up screen, click [Yes] to perform the update.
When the update is complete, [Completed. Please turn power off.] will appear.
- ⑤ Turn off the power of the CU to restart it.

Language Pack Installation

Install the language pack.

- ① Select the bank onto which you want to install the language pack.
- ② Click [Browse] to display the file select screen and select the language file you want to install.
- ③ Click [Install] to install the language pack.
When the installation is complete, [Completed. You will be automatically logged out momentarily.] will appear and you will be automatically logged out of Web Remote in 2 seconds.
To continue the operation, log in to Web Remote again.

Reset All Settings to Default

CU Reset All Dflt.

Restores both CU(s) and DU(s) to the default settings (this does not change the firmware version).

- ① When [Do you really want to reset all settings to default?] appears, click [Yes]. The confirmation message will appear again.
- ② Click [Yes] to restore the default settings.
[Completed. Please turn power off.] will appear.
- ③ Turn off the power of the CU to restart it.

Menu item ② ([Install Settings])

The setting values and default setting of each item you can set from [Install Settings] are as follows.

The item names with **CU** on the left are the names displayed on the CU display.

Items with **P** are included in the preset settings.

CU Audio Settings ([CU Audio])

Item name		Description and setting values (default settings are shown in bold)
Input Settings		Set the type and level for the Mic/Line audio inputs 1 and 2. 1 and 2 can be configured individually.
Mic/Line 1-2		
Type CU Input Type	P	Set the input type. Mic , Line +4dBu, Line 0dBV
Input Gain	P	Set the input gain of the Mic inputs (only when [Type] is set to [Mic]). -24 to +20dB (0dB)
Level	P	Set the Mic/Line input level. The level can be set individually for each input type (Mic or Line). -∞, -120 to +10dB (0dB)
Level Meter		Displays the input level with a level meter.
EQ Library	P	Select the EQ pattern for the Mic/Line inputs. The EQ pattern can be selected for each input type (Mic or Line). Flat HH Dyn M: Dynamic Handheld Microphone for Male HH Dyn F: Dynamic Handheld Microphone for Female HH Cond M: Condenser Handheld Microphone for Male HH Cond F: Condenser Handheld Microphone for Female Lavalier M: Lavalier Microphone for Male Lavalier F: Lavalier Microphone for Female (IP Remote*) * [IP Remote] appears when the equalizer is adjusted from [IP Control Settings]. [IP Remote] cannot be selected from the drop-down list.
Low Cut	P	Enable/disable low frequency reduction for the Mic input. On , Off
Phantom CU Phantom Power	P	Enable/disable phantom power (+48V). On , Off
Mix to Floor	P	Set whether to mix the input sound to the floor channel. On , Off
Aux		Configure the external input settings such as audio type and level.
Type	P	Set the nominal level of the external input. 0dBV , -10dBV, -20dBV
Level	P	Set the input level of the external input. -∞, -120 to +10dB (0dB)
Level Meter		Display the input level with a level meter.
Low Cut		Enable/disable low frequency reduction for the external input. On , Off
Mix to Floor	P	Set whether to mix the external input sound to the floor channel. On , Off
Return 1-2		Configure the level of the return input and the EQ pattern for the return input.
Type	P	Set the nominal level of the return inputs. +4dBu , 0dBV
Level	P	Set the input level of the return input. -∞, -120 to +10dB (0dB)
Level Meter		Displays the input level with a level meter.
Low Cut	P	Enable/disable low frequency reduction for the return input. On , Off

Feedback Suppression Settings		
FBS		
Enabled		Configure the FBS (Feedback Processor) settings. Ticking the checkbox sets FBS of the corresponding [Audio Group] to [On] and makes the setting button selectable. Click the setting button to open the [Feedback Suppression Settings] screen and configure advanced settings. On, Off
Band #1-12		
Frequency		Detects feedback and displays the frequency with the notch filter applied. When [Static] is set to [Off], the frequency dynamically changes according to feedback detected. * When [Static] is set to [On], the [Frequency] value is included in the preset setting as the frequency of the static filter.
Fixed		Lock the filter frequency by switching to the static filter. On, Off
Reset		Unlock all locked frequencies.
Detection		Configure the detection sensitivity of feedback frequency. Low, Mid , High
Response		Configure the detection speed of feedback frequency. Slow, Fast
Output Settings		Configure the output audio-related settings for each of OUTPUT terminals 1 to 4.
Output 1-4		
Source		Set the audio source to output. Floor, Group 0, Group 1, Group 2, Group 3, Language 1, Language 2, Language 3, Sub Mix 1, Sub Mix 2 (The default settings are as follows: Output 1: Floor , Output 2: Group 1 , Output 3: Group 2 , Output 4: Group 3)
PEQ (Output 1 only)		Configure the parametric equalizer (PEQ) settings. Ticking the checkbox sets PEQ of the corresponding output to [On] and makes the setting button selectable. Click the setting button to open the [PEQ Settings] screen and then configure settings for each of bands 1 to 8.
PEQ Enabled		Switch the PEQ setting between on and off. On, Off
Frequency (Band#1 - Band#8)		Set the frequency for each of [Band#1] to [Band#8]. 20Hz to 20kHz (The default setting for each of [Band#1] to [Band#8] is as follows. 25, 63, 160, 400, 1000, 2500, 6300, 16000)
Gain (Band#1 - Band#8)		Set the gain for each of [Band#1] to [Band#8]. -18dB to +10dB; adjustable in 0.5dB increments (0dB) • For [Band#1], [Gain] is configurable only when [Filter Type] is set to [LSH] or [PEQ]. • For [Band#8], [Gain] is configurable only when [Filter Type] is set to [HSH] or [PEQ].
Q (Band#1 - Band#8)		Set the Q value for each of [Band#1] to [Band#8]. • For [Band#1] and [Band#8], the Q value is configurable only when PEQ is enabled. 0.3 to 30 (10)
Filter Type (Band#1)		Set the filter type for [Band#1]. HPF, LSH, PEQ
Filter Type (Band#8)		Set the filter type for [Band#8]. LPF, HSH, PEQ
Reset		Restores specified band to the factory default settings.
Reset All		Restores all bands to the factory default settings.

DYN (Output 1 only)		Configure the DYN (dynamics) settings. Ticking the checkbox sets DYN of Output 1 to [On] and makes the setting button () selectable. Click the setting button () to open the [Dynamics Settings] screen and then configure various settings as follows.
Enabled		Enable/disable the dynamics settings. On, Off
Gain Reduction		Displays audio compressed by the compressor in real time.
Comp Threshold		Configure the compressor threshold. The compressor functions only for audio signals exceeding the specified value. -60 to 0dB (-10)
Ratio		Set the compression ratio. 1.4:1, 2:1 , 4:1, 6:1, 10:1, ∞:1
Attack Time		Set the delay for the start of compression after audio signals exceed the threshold. 0, 0.25, 0.5, 1, 2, 4, 8, 16, 32, 100msec (1msec)
Release Time		Set the delay for the end of compression after audio signals fall back within the threshold. 50, 100, 200, 400, 800, 1000, 2000msec (400msec)
Limiters Threshold		Set the limiter threshold. Audio signals exceeding the specified value will be cut out by the limiter. -60 to 0dB (-10)
Level		Set the output level. -∞, -120 to +10dB (-40dB)
Max Volume (Output 1 only)		Set the maximum volume level. -∞, -120 to +10dB

DU Settings ([DU])

Item name		Description and setting values (default settings are shown in bold)
Global DU Settings		Configure DU common settings.
Speaker Level DU SP Output Lvl		Set the speaker output level. 0 to 20 (10)
Voice Detection Sensitivity VoiceDetectSens		Set the detection level when voices are detected in automatic mode. When [Auto relative to Mic2 Input] is selected, by inputting collected environmental background noise in the MIC2 Input terminal, the detection level is automatically adjusted to match the noise level. -5, -4, -3, -2, -1, 0, 1, 2, 3, 4, 5, Auto relative to Mic2 Input / Auto by Mic2 In (0dB)
Talk LED Color(*1)		Set the (talk) LED colors.
Talk ON		Set the (talk) LED color when talking. 10 colors (Red)
Queuing		Set the (talk) LED color when waiting to talk. 10 colors (Green)
Individual DU Settings (Max. 150 units)		Configure settings individually for each DU.
Connected DUs		Displays setting information of all DUs connected to the system. You can check and change settings.
LED		Check that the DU LED lights up. The rear LED and (talk) LED on the DU as well as the ring LED on the ATUC-M blink while the corresponding (talk) icon on the screen is lit.
Priority		Enable/disable the DU priority setting(*2). The maximum number of DUs that can be designated as priority DU is 1 unit less than the maximum number of DUs (speakers) that can talk at the same time (▶ page 34). On, Off
Serial#		Displays the serial number.
Delegate Name		Assign names (e.g. attendee names) to differentiate DUs. You can use up to 30 characters. (8-digit number)
Audio Group		The output signals from each DU can be categorized into 4 types (audio groups). One or more audio groups can be selected as output destination(s), and furthermore, the output terminal on the CU can be specified for each group (▶ page 30). Group 0 , Group 1, Group 2, Group 3

Color		Select a color for the rear LED from the drop-down list. 10 colors (Red)
Operations for the DU(*3)		Select 1 or more DUs from the list and perform the following operations. Edit Detail Settings, Copy, Select all, Deselect all, Delete

***1: About setting changes**

Settings can be changed when all DUs are in the Talk OFF state.

***2: About the priority setting**

Priority DU(s) are given authorization to do the following:

- Talk anytime
- Cut short or temporarily mute all other attendees simultaneously

It is assumed that the priority setting is enabled on DUs that are used by people in charge of the proceedings of a conference, such as a chairman or company directors who are permitted to talk anytime.

***3: Operations for the DUs**

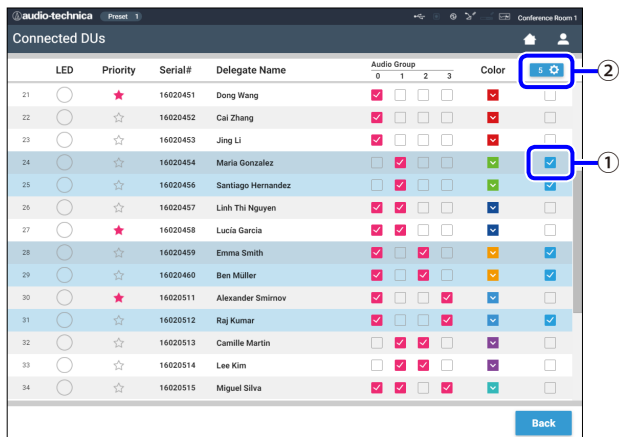

LED	Priority	Serial#	Delegate Name	Audio Group	Color
				0 1 2 3	
21	★	16020451	Dong Wang	✓	Red
22	☆	16020452	Cai Zhang	✓	Red
23	☆	16020453	Jing Li	✓	Red
24	☆	16020454	Maria Gonzalez	✓	Green
25	☆	16020456	Santiago Hernandez	✓	Green
26	☆	16020457	Linh Thi Nguyen	✓	Blue
27	★	16020458	Lucia Garcia	✓	Blue
28	☆	16020459	Emma Smith	✓	Orange
29	☆	16020460	Ben Müller	✓	Blue
30	★	16020511	Alexander Smlimov	✓	Blue
31	☆	16020512	Raj Kumar	✓	Blue
32	☆	16020513	Camille Martin	✓	Blue
33	☆	16020514	Lee Kim	✓	Purple
34	☆	16020515	Miguel Silva	✓	Green

1 Click ① of the DU(s) for which you want to adjust the settings.

A check mark will be inserted in the checkbox.

You can also select multiple DUs and simultaneously change settings of the selected DUs.

2 Click ② to display the drop-down list and proceed to the following operations.

 • The number displayed on ② is the number of selected DUs.

Edit Detail Settings:

Simultaneously configure detailed settings for the selected DUs (refer to the [DU Detail Settings] table below).

When multiple DUs are selected, setting items for which the current values differ among the DUs will be grayed out.

- Items which remain grayed out: Setting values of each DU are retained.
- Grayed out items which become selectable after operation: Setting values of all selected DUs will be changed to the displayed values.

Copy:

Copies settings of the selected DU and pastes to other DUs.

- ① Select 1 DU from which you want to copy settings.
- ② Select [Copy] from the drop-down list.
All checkboxes, icons and the like except DU select checkboxes will be unselectable.
- ③ Select the DU(s) to which you want to paste the settings.
- ④ Press the [Paste] button.

NOTICE • Before performing copy operation, check that all DUs are in the Talk OFF state.

Delete:

Deletes the selected DU(s) from the list. Only DU(s) in a disconnected state can be deleted.

Select all:













Selects all DUs.

Deselect all:

Deselects all DUs.

 • Depending on the DU selection state, some items above may not appear.

DU Detail Settings ([DU Detail Settings])

Item name		Description and setting values (default settings are shown in bold)
Microphone		Configure microphone-related settings.
Level Meter		Displays the level with a level meter.
Input Gain		Set the microphone input gain. -20dB to +20dB (0dB)
AGC		Enable/disable AGC (Automatic Gain Control). On, Off NOTICE • When operating the system with [AGC] set to [On], set the [Mode When Talk ON] setting under [Speaker] to [Attenuation] or [Off].
EQ Library		Set the EQ pattern for the microphone input. Flat , Neutral Male, Neutral Female, Clear Male, Clear Female, Warm Male, Warm Female, AT ES Series, AT UniPoint, (IP Remote*) * [IP Remote] appears when the equalizer is adjusted from [IP Control Settings]. [IP Remote] cannot be selected from the drop-down list.
Mic ON Trigger		Set whether to manually turn on the microphone by pressing the  (talk) button or to automatically turn on the microphone when a voice is detected. Button , Voice
Phantom Power		Enable/disable the phantom power supply to the microphone. On, Off
Speaker		
Enabled		Enable/disable the DU speaker. On, Off
Mode When Talk ON		The attendee switches speaker mode while talking. When [Attenuation] is selected, the ducking feature lowers the volume level by -20dB (this item appears only when the speaker is enabled). On, Attenuation , Off
Audio Group		The CU categorizes the audio signals transmitted from the DUs and then outputs the signals to the specified channels.
Assign		Up to 4 channels can be specified for each DU. Multiple groups can be selected and output channels can be selected for each group (▶ page 30). Group 0 , Group 1, Group 2, Group 3
Rear LED Color		
Talk ON / Queuing		Select a color for the rear LED from the drop-down list. 10 colors (Red)
Priority		Configure the priority (▶ page 32) settings.
Enabled		Enable/disable the priority setting. The maximum number of DUs that can be designated as priority DU is 1 unit less than the maximum number of DUs (speakers) that can talk at the same time (▶ page 34). On, Off
Can Cut/Mute		Set whether the priority DU user can temporarily cut short/mute other DUs. On, Off
Can be Cut/Muted		Set whether the priority DU are temporarily cut short/muted by other DUs. On, Off

Conference Settings ([Conference])

Select the conference mode according to the conference operation and control method and configure detailed settings.

 • The following setting items are also included in [Setup Conference] where you can configure the same settings.

• [Free Talk]

In this mode, attendees can talk when the  (talk) button is pressed or when their DUs automatically detect their voices.

• [Request Talk]



















In this mode, attendees request to talk by pressing the  (talk) button on the DU and will be permitted to talk by the steering committee. The steering committee can also reject the talk request.

To operate the conference in this mode, connect the CU to a control device such as a computer.

• [Full Remote]

In this mode, utterances are totally controlled via Web Remote. The DU  (talk) button operations will be disabled.

To operate the conference in this mode, connect the CU to a control device such as a computer.

Item name		Description and setting values (default settings are shown in bold)
Conference Settings		Select the conference mode and configure detailed settings
Conference Mode		Select the conference mode. Free Talk , Request Talk, Full Remote
Number of Open Mics(*1)  NOM		Set the maximum number of the DUs (speakers) that can talk at the same time. 10 to 1
Auto Mic OFF(*1)  Auto Mic Off		Set the time interval until the microphone automatically turns off after the speaker stops talking (after a soundless state is detected). 5 to 60sec, Off; adjustable in 5-second increments (Off)
Override Mode (Free Talk Mode)(*1)		Select the override method(*2) in [Free Talk] Mode. No Override , FIFO, LIFO
Override Mode (Request Talk Mode)(*1)		Select the override method(*2) in [Request Talk] Mode. FIFO , LIFO
Override Mode (Full Remote Mode)(*1)		Select the override method(*2) in [Full Remote] Mode. FIFO , LIFO
Maximum in Queue(*1)  Max Queue		Set the maximum number of DUs that can be in talk standby mode at the same time. 0 to 150 (50 units)
Mic ON Trigger / Mic ON Trigger for Priority(*1)  MicON Trigger		Set whether to manually turn on the microphone by pressing the  (talk) button or to automatically turn on the microphone when a voice is detected, for all DUs. When [Conference Mode] is set to [Request Talk] or [Full Remote], this item switches to [Mic ON Trigger for Priority], which is the setting for priority DUs. All Button , All Voice, (Individual*) * The setting value displayed is depending on the setting values for each DU. When all DUs are set to [Button], [All Button] appears, and when all DUs are set to [Voice], [All Voice] appears. When some DUs are set to [Button] and others are set to [Voice], [Individual] appears. [Individual] cannot be performed as a function.
Mic ON Hold Time(*1)  MicON Hold Time		Specify the time until the microphone automatically turns off on DUs where [Mic ON Trigger] is set to [Voice]. The microphone automatically turns off when the attendee keeps silent for the specified time. 1.0 to 10.0 seconds; adjustable in 0.5-second increments (2.5 seconds)
Priority Mode		Set the operation when the user of the priority DU ( page 32) presses and holds the DU  (talk) button.
Interrupt Option(*1)		Set whether the priority DU user cuts short or temporarily mutes other DU users by pressing and holding the  (talk) button. Cut , Mute

SFX 1-3 Setting		You can register up to 3 audio files such as a buzzer and a chime. Registered audio files are assigned to the 3 buttons displayed on the [Audio Control] screen and these audio files can be played as you like (▶ page 41).																
Name		Specify names for buttons to which audio files are assigned. (Up to 15 characters) SFX1 to 3																
Source		Select the desired audio file from a designated folder on the USB device (mass storage device) connected to the CU. Copy audio files to the root directory of the USB device (mass storage device). Up to 30 files can be displayed in the drop-down list. Playback(*1) <table border="1"> <tr> <td rowspan="2">WAV</td> <td>Data length</td> <td>16bit, 24bit</td> </tr> <tr> <td>Sampling frequency</td> <td>48kHz</td> </tr> <tr> <td rowspan="2">MP3(*2)</td> <td>Bit rate</td> <td>32-320kbps</td> </tr> <tr> <td>Sampling frequency</td> <td>48kHz</td> </tr> <tr> <td colspan="2">Maximum file size</td> <td>2GB</td> </tr> <tr> <td colspan="2">Maximum number of files</td> <td>30files</td> </tr> </table> *1 Supported file systems: FAT16/FAT32 *2 Supported format: MPEG-1 Audio Layer-3.	WAV	Data length	16bit, 24bit	Sampling frequency	48kHz	MP3(*2)	Bit rate	32-320kbps	Sampling frequency	48kHz	Maximum file size		2GB	Maximum number of files		30files
WAV	Data length	16bit, 24bit																
	Sampling frequency	48kHz																
MP3(*2)	Bit rate	32-320kbps																
	Sampling frequency	48kHz																
Maximum file size		2GB																
Maximum number of files		30files																

***1 About setting changes**

Settings can be changed when all DUs are in the Talk OFF state.

***2 About the override setting**

Specify which DU (speaker) is cut short and which DU's request will be permitted if the number of DUs (speakers) who can talk at the same time has already reached the specified maximum limit ([Number of Open Mics]) and more attendees press the (talk) button.

FIFO (First-In First-Out):

Cuts short the speaker who was least recently permitted to talk and permits the person who has just pressed the (talk) button to talk.

LIFO (Last-In First-Out):

Cuts short the speaker who was most recently permitted to talk and permits the person who has just pressed the (talk) button to talk.

No Override: (unselectable while in [Request Talk] Mode or [Full Remote] Mode)

The person who has just pressed the (talk) button will be in talk standby and will be permitted to talk when his/her turn comes.

Recording Settings ([Recorder])

NOTICE • Recording settings can be configured only when recording stops.

Item name		Description and setting values (default settings are shown in bold)
USB Recorder Settings		
Record File Format Rec Format		Select the conference recording format. WAV , MP3
Recording Quality		Set the bit rates for recording speech in MP3 format. 64, 128, 192, 256, 320 kbps
Number of Recording Channels (WAV) No.of Rec CH		Set the number of recording audio channels when the recording format is WAV. 1 to 4
Number of Recording Channels (MP3) No.of Rec CH		Set the number of recording audio channels when the recording format is MP3. 1 to 2
Recording Source Track1, Track2, Track3, Track4 Rec Source CH1-CH4		Set the recording source for each channel (Sub Mix 1, 2 and Language 1, 2, 3 will not be available depending on the setting state). Floor , Group 0, Group 1, Group 2, Group 3, Language 1, Language 2, Language 3, Sub Mix 1, Sub Mix 2
Auto Track		Split audio files by the specified time while recording or disable this function. Off , 15 min, 30 min, 1 hour, 2 hours

Rec Filename Prefix
Filename Prefix



Specify prefix for recorded audio files.

Up to 30 characters can be used. (Some characters cannot be used (▶ page 12). The default setting is **atuc-50**.)

Accessing your presets ([Presets])

Recall, save, import/export presets.

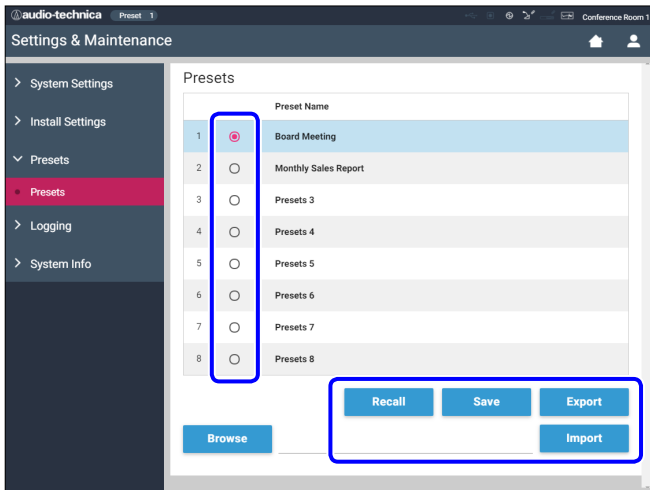

1 Click on the right side of the preset number you want to select.

will light red and the field of the selected preset will be highlighted in light blue.

2 Click the operation you want to perform.

The selected operation will be executed.

Recall (Recall Presets):

Sets the selected preset as the current setting.

Save (Save Presets):

Saves the current setting to the selected preset number. The setting items with "P" in the table are included in the preset.

Export (Export Presets):

Exports the preset data to an external device. From the pop-up window, select the folder where you want to export the data.

Import (Import Presets):

Imports the preset data that was exported to an external device. From the pop-up window, select the preset data file you want to import.



To edit the preset name, click the name. You can use up to 30 characters.

Log management ([Logging])

Configure the system log settings. You can also download the log file.

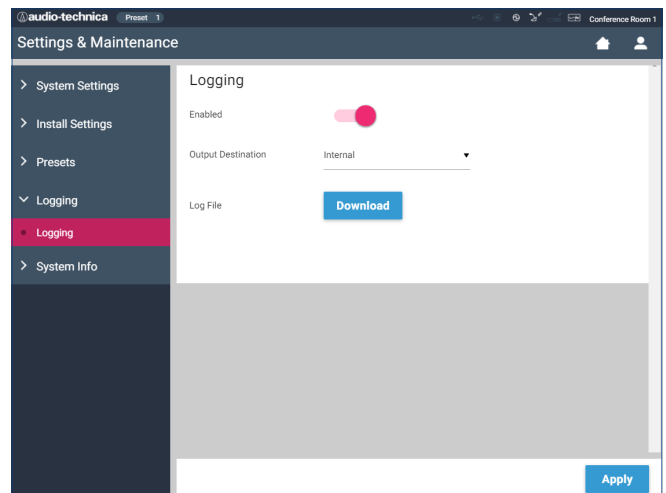

Enabled (Logging):

Set whether to save the system log. (On, Off)

Output Destination (Destination):

Set whether to export the log file to a USB device (mass storage device). (Internal, USB)

Log File:

Select the download destination and download the log file to the specified destination.

Displaying the system information ([System Info])

Display the system information such as the firmware version, various network setting statuses, and unit serial numbers.

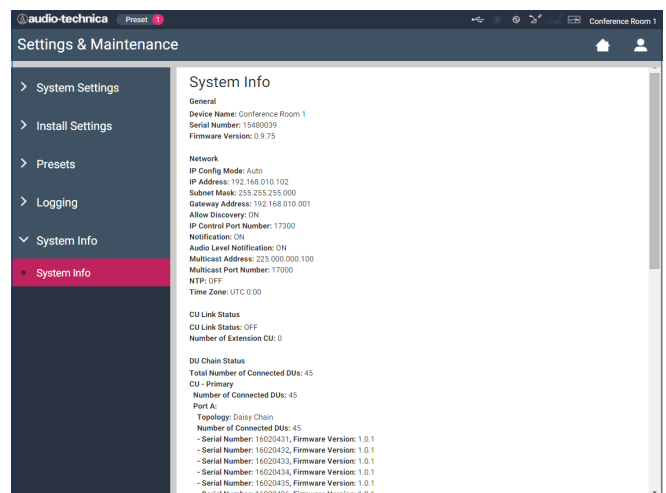

Preparing for conferences ([Setup Conference])

To handle many different types of conferences using an ATUC-50 system, it is recommended to preset multiple types of conference settings. Basic conference preparation can be carried out simply by recalling the preset that best suits an upcoming conference.

Up to 8 conference settings can be preset.

You can also change settings saved on the recalled preset to suit the upcoming conference.

Prepare for the upcoming conference in 3 steps by utilizing the preset function.

1 Recalling the preset ([Recall Preset])

The [Recall Preset] screen will appear if you click [Setup Conference] on the Home screen (▶ page 23).

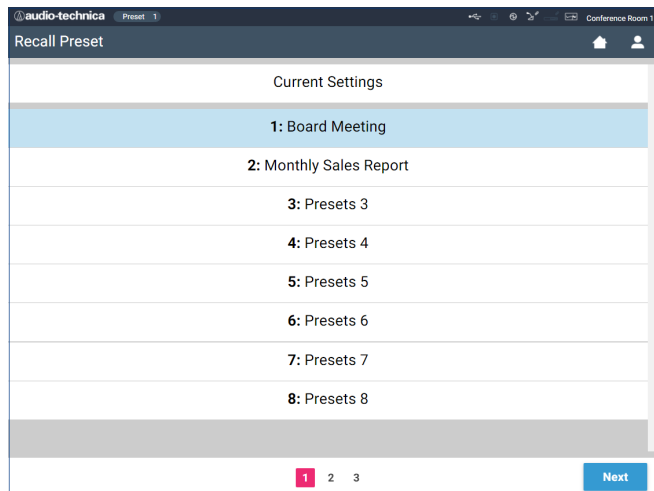

For starting a conference using the most recently used conference setting (Current Settings) or one of the preset settings, follow the procedure below to display the [Conference Manager] screen.

1 On the [Recall Preset] screen, select [Current Settings] or your desired preset and then click [Next].

NOTICE • Before clicking [Next], check that all DUs are in the Talk OFF state. If there is a DU in the Talk ON state, the setting values cannot be read.

 • To configure settings based on the current setting, select [Current Settings].

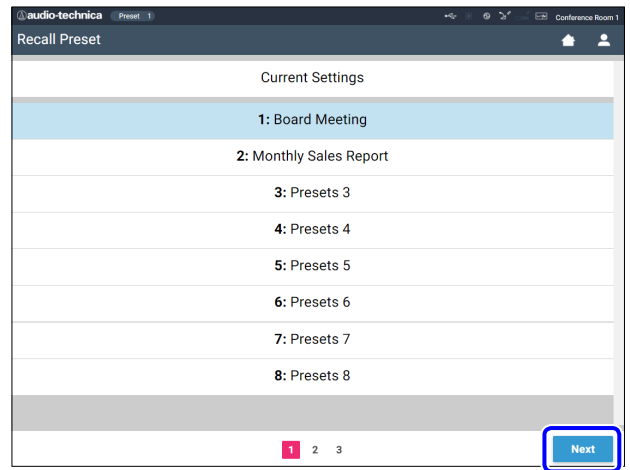

Recalls the preset and then displays the [Conference Settings] screen.

2 Changing the conference settings ([Conference Settings])

1 Change the settings as necessary and then click [Next].

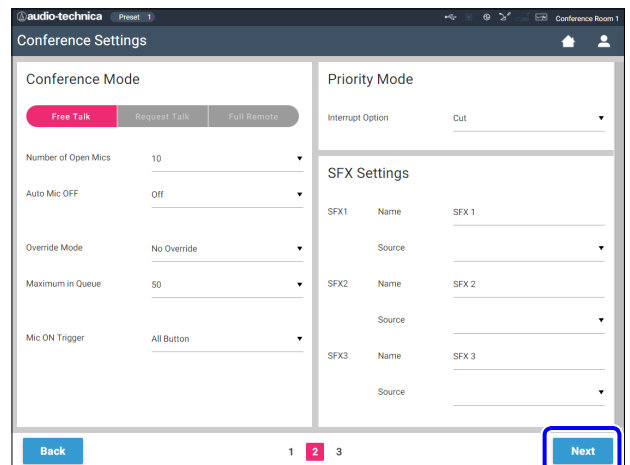

Saves the settings and displays the [DU Settings] screen.

3 Adjusting the DU settings ([DU Settings], [DU Detail Settings])

Configure DU settings and DU detail settings.

1 Change the settings as necessary.

To configure detail settings:

Proceed to step 2.

To finish settings without configuring detail settings:

Click [Next], then click [Done].

LED	Priority	Delegate Name	Audio Group	Color
21	★	Dong Wang	0	Red
22	☆	Cai Zhang	0	Red
23	☆	Jing Li	0	Red
24	☆	Maria Gonzalez	1	Green
25	☆	Santiago Hernandez	0	Green
26	☆	Linh Thi Nguyen	0	Blue
27	★	Lucia Garcia	0	Blue
28	☆	Emma Smith	0	Yellow
29	☆	Ben Müller	0	Yellow
30	★	Alexander Smirnov	0	Blue
31	☆	Raj Kumar	0	Blue
32	☆	Camille Martin	0	Purple
33	☆	Lee Kim	0	Purple
34	☆	Miguel Silva	0	Green

- For details on each setting item, refer to the [DU Settings] item table (▶ page 31).

2 Click ① of the DU(s) for which you want to change the settings, to enter a ✓ mark.

- From the drop-down list ②, you can select/unselect all DUs.
- The number shown on ② indicates the number of the currently selected DUs.
- ① and ② will not appear if the currently logged in Operator is not permitted to access these settings.

3 From the drop-down list ②, click [Edit Detail Settings].

Displays the [DU Detail Settings] screen and enables you to configure DU detail settings.

4 Configure DU detail settings and click [Apply] to apply the changes.

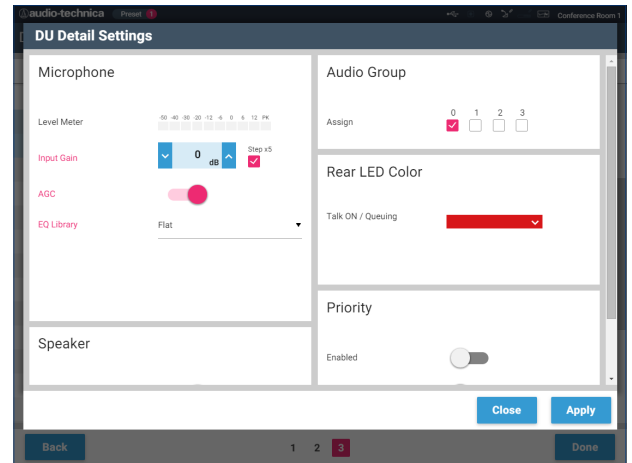

Returns to the [DU Settings] screen.

- For details on each setting item, refer to the [DU Detail Settings] item table (▶ page 33).
- When multiple DUs are selected, setting items for which the current values differ among the DUs will be grayed out. These setting items cannot be adjusted.
- The [Phantom Power] setting for DUs can be configured from [Settings & Maintenance] → [Install Settings] → [DU] → [Individual DU Settings] → [Connected DUs] → [Edit Detail Settings] → [DU Detail Settings] (▶ page 33).

5 Click [Done] on the bottom right of the screen.

The [Conference Manager] screen under [Start Conference] appears (▶ page 40) indicating that the system is ready to start the conference.

Operating and controlling conferences ([Start Conference])

The [Start Conference] screen is displayed by clicking [Start Conference] (▶ page 23) or after finishing conference settings from [Setup Conference].

Operate and control a conference underway. You can also change detailed settings of the conference underway.

Using the tabs on the upper side of the screen, conference mode can be switched between the following 3 modes.

1 [Conference Manager]

- Settings and management for attendees
- Utterance control
- DU detailed settings

2 [Audio Control]

- Speech output level adjustment
- Conference recording operations
- Audio playback operation such as chime

3 [Conference Settings]

- Conference mode settings and various detailed settings
- Audio playback settings such as chime

1 Operating conferences ([Conference Manager])

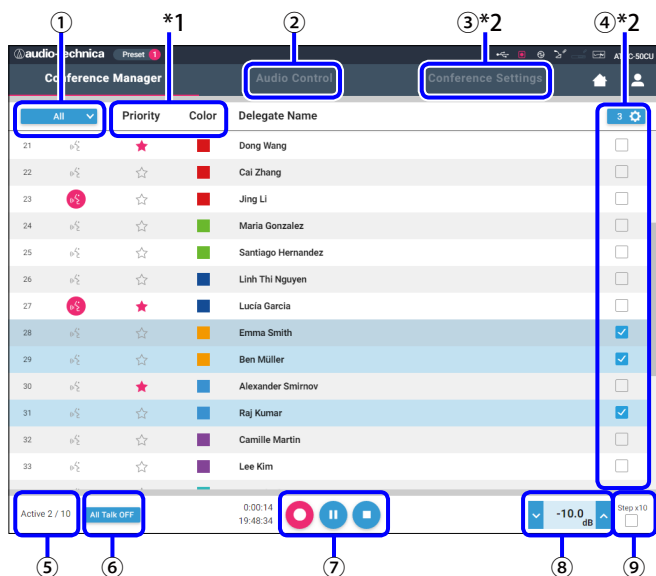

- 1 Select [All] to display all connected DUs or [Active] to display currently talking speakers.
- 2 Displays the [Audio Control] screen (▶ page 41).
- 3 Displays the [Conference Settings] screen (▶ page 41).
- 4 Displays the [DU Detail Settings] screen (▶ page 39).
- 5 Indicates the number of speakers currently talking. The numerator is the number of speakers and the denominator is the maximum number of DUs (speakers) that can talk at the same time.
- 6 Cuts short all currently talking DU users.

- 7 Perform the recording operations. See “Recording operations” (▶ page 41).
- 8 Click repeatedly to adjust the volume level. Click the up/down buttons to adjust the volume level for OUTPUT 1. By ticking the checkbox 9, the level can be adjusted in [Step x10] increments.

*1 From the [Conference Manager] screen, the [Priority] and [Color] settings are not configurable.

*2 When the Operator access authority is set to [Limited], these items are not displayed.

 • The operation and setting items other than 1 to 9 described above are the same as the items on the [DU Settings] screen (▶ page 39).

When in Request Talk Mode:

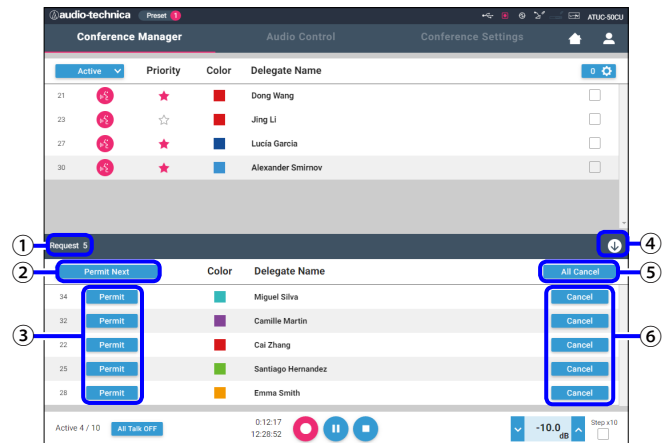



In Request Talk Mode, in addition to the DU list, the list of DUs requesting to talk can also be displayed.

- 1 The number of DUs requesting to talk
- 2 Permits the DU on the top of the list to talk
- 3 Permits the corresponding DU to talk
- 4 Opens/closes the request list
- 5 Cancels all requests to talk
- 6 Cancels request to talk from the corresponding DU



Recording operations:

Recording operations such as starting and stopping recording can be performed either on the [Conference Manager] screen or on the [Audio Control] screen (▶ page 41). On the [Audio Control] screen, you can both configure the advanced audio-related settings and perform audio operations.

Perform the recording operations using the following 3 buttons available at the bottom of the [Conference Manager] screen.

-  Rec button
Starts recording.
-  Pause button
Pauses recording.
-  Stop button
Stops recording.

About button colors:

-  Buttons in this color cannot be operated.
-  Buttons in this color can be operated.
-  Buttons in this color are currently being operated.
If you press a button, the button turns this color.

2 Configuring the advanced audio-related settings and performing audio operations ([Audio Control])

Click the [Audio Control] tab to proceed to the [Audio Control] screen.

You can perform the recording operations and configure the advanced audio-related settings on one screen.



- ① This is the OUTPUT 1 level meter and indicates the level of audio output from OUTPUT 1.
- ② Adjust the OUTPUT 1 level. Be sure not to light up the red indicator (PK) of the level meter ① while adjusting the level.
- ③ Adjust the SFX playback level while checking the level with the level meter ① etc.
- ④ These are SFX operation buttons. Audio files set from [Conference Settings] are played (▶ page 38). Pressing an SFX

button plays the corresponding audio file. Click the button again to stop playing.

- ⑤ This is the recording level meter and indicates the level of the voice currently being recorded. (Even in recording pause mode, the voice level meter activates when detecting voices.)
- ⑥ Adjust the recording level. Be sure not to light up the red indicator (PK) of the recording level meter ⑤ while adjusting the level.
- ⑦ This is the elapsed recording time. In recording stop mode, the remaining recording time is displayed instead.
- ⑧ This is the available recording time.

 • The operation and setting items other than ① to ⑧ described above are the same as the items on the [Conference Manager] screen (▶ page 40).

3 Configuring conference settings ([Conference Settings])

Click the [Conference Settings] tab to display the [Conference Settings] screen.

According to the conference control and operation methods, select conference mode and configure detailed settings.

The operations and settings are the same as [Settings & Maintenance] → [Install Settings] → [Conference] (▶ page 34).

Information

Troubleshooting

If a problem should arise, first check the following:

1. Check your connections.
2. Verify that the system is being operated as described in this instruction manual.
3. Check that the external devices are operating properly. Check the operation while the devices are not connected to the CU.
4. Restart your network devices.

If any unit in the system is not operating properly, check the items listed in the table below.

If the symptom is not covered on the checklist below, contact our sales representative.

When you contact us, you may be asked the firmware version. Please check the firmware version by following the procedure below.

To check from Web Remote:

[Settings & Maintenance] → [System Settings] → [Utilities]

or

[Settings & Maintenance] → [System Info]

To check on the CU display:



Set → Log in as Administrator or Operator → System Info

ATUC-50CU

Symptom	Cause/Solution	Page
Cannot turn on the power.	Check that the AC power cord is connected properly.	page 18
The connected microphone does not work.	Check the connection of the microphone.	page 8
	Check and adjust the MIC/LINE 1/2 settings. To check from Web Remote: [Settings & Maintenance] → [Install Settings] → [CU Audio] → [Input Settings]	page 29
	To check on the CU display: Set → Log in as Administrator or Operator → Audio Setting	page 7
The sound from the connected speaker is distorted or cannot be heard.	Check the connections of all devices.	page 8
	Plug the connection cables all the way in.	-
	Check that the inputs and outputs of all devices are connected properly.	page 8
	Check that terminal pin assignments (Hot/Cold/GND, etc.) are correct.	page 8
	Check that the cables are not damaged.	-
	Check and adjust the setting of the connected amplifier.	-
Cannot record sound.	Check the remaining memory on the USB device (mass storage device).	-
	Reconnect the USB device (mass storage device) or try with a different USB device (mass storage device).	-
Although recording has performed properly, when playing the recorded files using a device such as a computer, no sound is heard.	Check that the recording channel set from [Rec source] is correct. To check from Web Remote: [Settings & Maintenance] → [Install Settings] → [Recorder] → [USB Recorder Settings] To check on the CU display: Set → Log in as Administrator or Operator → Recorder Setting	page 35 page 7

Symptom	Cause/Solution	Page
You forget the password.	<p>Follow the procedure below to reset the password.</p> <ol style="list-style-type: none"> ① Display the HOME screen of the CU display and then while pressing the BACK button on the CU front panel, rotate the jog dial clockwise until it clicks 3 times. ② While pressing the BACK button, rotate the jog dial counterclockwise until it clicks 3 times. ③ While pressing the BACK button, press the ENTER button. 	page 6

ATUC-50DU

Symptom	Cause/Solution	Page
Cannot turn on the power.	Check the connection to the CU or other DUs.	pages 13, 14
The  (talk) button does not function.	<p>Depending on the conference mode or setting, the  (talk) button may not function. Check the conference mode settings.</p> <p>To check from Web Remote: [Settings & Maintenance] → [Install Settings] → [Conference] → [Conference Mode]</p> <p>To check on the CU display: <i>Set</i> → Log in as <i>Administrator</i> or <i>Operator</i> → <i>Conference Mode</i></p>	<p>page 34</p> <p>page 7</p>
No sound is output from the headphone jack.	Insert the headphone plug all the way in.	-
	Raise the volume with the + button.	page 9
No sound is output from the built-in speaker.	Check the connection of the DUs.	page 14
	Plug the Ethernet cable all the way in.	-
	Check that the cables are not damaged.	-
	From [Settings & Maintenance] → [Install Settings] → [DU] → [DU Detail Settings], check that the [Speaker] setting is set to [Enabled].	page 33
	<p>Adjust the speaker level.</p> <p>To check from Web Remote: [Settings & Maintenance] → [Install Settings] → [Global DU Settings] → [Speaker Level]</p> <p>To check on the CU display: <i>Set</i> → Log in as <i>Administrator</i> or <i>Operator</i> → <i>Audio Setting</i> → <i>DU SP Output Lvl</i></p>	<p>page 31</p> <p>page 7</p>
The ATUC-M does not operate.	Insert the ATUC-M connector into the microphone jack on the DU until a clicking sound is heard.	page 18
	<p>From [Settings & Maintenance] → [Install Settings] → [DU] → [DU Detail Settings], check the setting of [Microphone].</p> <ul style="list-style-type: none"> • Check that [Phantom Power] is not set to [Off]. • Check that [Input Gain] is not too low. 	page 33

Web Remote

Symptom	Cause/Solution	Page
“Locate” does not recognize the CU that you want to control via Web Remote.	Check the connections of units including the CU and the control device such as a computer.	page 19
	Check that the CU and the control device such as a computer are connected to the same network.	-
The CU you want to control via Web Remote is grayed out on “Locate.”	When multiple CUs are cascaded and CU LINK is functioning, the CU(s) is grayed out on “Locate” while it is set to [Extension] from [General] → [CU Link Settings] → [Primary/Extension]. Check the setting again.	page 25
Cannot start Web Remote on your control device such as a tablet or iPad.	Check that the control device is connected to a correct access point.	-
	Check that the CU and the control device such as a tablet or iPad are connected to the same network.	-
You forget the password.	Follow the procedure below to reset the password. ① Display the HOME screen of the CU display and then while pressing down the BACK button on the CU front panel, rotate the jog dial clockwise until it clicks 3 times. ② While pressing down the BACK button, rotate the jog dial counterclockwise until it clicks 3 times. ③ While pressing the BACK button, press the ENTER button.	page 6

Error messages

- Error messages displayed on the Web Remote screen and CU displays are as follows.
- The states of the CU LED error indicators are described together with the CU display error messages.
- If the same error persists even after the following remedies are taken, or when the unit(s) requires repair or parts replacement, contact our sales representative.

	Web Remote	CU display (LED indicators)	State/remedies
1	Resume Data Error	Resume Data Err	Failed to read the resume information. <ul style="list-style-type: none"> • The unit was started up using the second from the last setting or default setting. Although there is no functional limitation, be sure to restart the unit to check that the same error does not occur again.
2	Preset Data Error	Pst Data Err	Failed to read the preset data. <ul style="list-style-type: none"> • This error may occur when you recall the default preset or the preset which you successfully recalled last time. Although there is no functional limitation, be sure to restart the unit to check that the same error does not occur again.
3	DU Power Error	DU Power Err (DU POWER: blinks green)	An error occurred when power was supplied to the DU. <ul style="list-style-type: none"> • Voltage may fall at the 48V output. ①After disconnecting all DUs from the CU, restart the CU. If the same error occurs again, the CU requires repair. ②If the same error does not occur again in ① but the error occurs again after connecting the DUs, there may be a damaged cable or DU. Identify the damaged cable or DU for replacement or repair.
4	DU Communication Error	DU Comm Err (DU CHAIN: blinks green)	DU individual settings cannot be configured. <ul style="list-style-type: none"> • Check that there is no DU connection error.
5	DU Ring to Daisy	DU Ring to Daisy (DU CHAIN: blinks green)	The DU topology has been changed (from ring to daisy). <ul style="list-style-type: none"> • If this error occurs even though you did not change the DU connection, check that there is no DU connection error.
6	DU Daisy to Ring	DU Daisy to Ring (DU CHAIN: blinks green)	The DU topology has been changed (from daisy to ring). <ul style="list-style-type: none"> • If this error occurs even though you did not change the DU connection, check that there is no DU connection error.
7	Number of DU Decreased	DU Number Decrease (DU CHAIN: blinks green)	The number of connected DUs decreased. <ul style="list-style-type: none"> • If this error occurs even though you did not change the DU connection, check that there is no DU connection error.
8	DU Exceeds 50 Units	DU Exceeds 50pcs (DU CHAIN: blinks green)	(1) More than 50 DUs are connected to the DU CHAIN A/B/C/D terminals in total. (2) More than 50 DUs are connected to the DU CHAIN A/B terminals in total. <ul style="list-style-type: none"> • Connect 50 DUs or less to each CU.
9	DU C/D: Exceeds 25 Units	DU C/D Exceeds 25pcs (DU CHAIN: blinks green)	More than 25 DUs are connected to the DU CHAIN C/D terminals in total. <ul style="list-style-type: none"> • Connect 25 DUs or less to the DU CHAIN C/D terminals in total.
10	CU Communication Error	CU Comm Err (CU LINK: blinks green)	A communication error occurred between the CUs. <ul style="list-style-type: none"> • Check that there is no CU connection error.
11	CU Link OFF	CU Link OFF (CU LINK: blinks green)	CU Link is cancelled. <ul style="list-style-type: none"> • If this error occurs unexpectedly, check that there is no CU connection error.
12	Network Communication Error	Network Comm Err (REMOTE: blinks green)	(1) A network communication error occurred. (2) An IP command communication error occurred. <ul style="list-style-type: none"> • Check that there is no network connection error.
13	USB Access Error	USB Access Err	An error occurred when accessing the USB device (mass storage device). <ul style="list-style-type: none"> • Check that the USB device (mass storage device) has no problems. • Check that the same error does not occur with another USB device (mass storage device).

	Web Remote	CU display (LED indicators)	State/remedies
14	USB Format Error	USB Format Err	There is a problem with the USB device (mass storage device). <ul style="list-style-type: none"> • Check the format of the USB device (mass storage device). • Use a USB device (mass storage device) formatted with FAT16 or FAT32.
15	Failed	Failed	(1) The setting cannot be configured due to some system errors. <ul style="list-style-type: none"> • Try to configure the setting again and check whether the same error occurs again. (2) Playback operation cannot be performed. <ul style="list-style-type: none"> • Check that the USB device (mass storage device) is connected properly. • Check that the file you want to play is in the USB device (mass storage device). • Check that the format of the file you want to play is correct. (You can check by, for example, playing the file with another playback device.) (3) Recording operation cannot be performed. <ul style="list-style-type: none"> • Check that the USB device (mass storage device) is inserted in the CU. • Check that write protection is disabled on the USB device (mass storage device). • Check the space available on the USB device (mass storage device). • Check that the USB device (mass storage device) has no problems. • Check that the same error does not occur with another USB device (mass storage device).
16	File Export Failed		(4) The preset data cannot be exported. <ul style="list-style-type: none"> • Check that the USB device (mass storage device) has no problems. • Check that the same error does not occur with another USB device (mass storage device).
17	File Import Failed		(5) The preset data cannot be imported. <ul style="list-style-type: none"> • Check that the USB device (mass storage device) has no problems. • Check that the same error does not occur with another USB device (mass storage device).
18	USB Write Error	USB Write Err	The data log cannot be saved onto the USB device (mass storage device). <ul style="list-style-type: none"> • Check that the USB device (mass storage device) is inserted to the CU. • Check that write protection is disabled on the USB device (mass storage device). • Check the space available on the USB device (mass storage device). • Check that the USB device (mass storage device) has no problems. • Check that the same error does not occur with another USB device (mass storage device).
19	Failed. Please turn power OFF.	CU FW Update Err Please Turn Pwr OFF	An error occurred during the CU firmware update. <ul style="list-style-type: none"> • Turn off the power and restart the CU.
20	Failed. Please turn power OFF.	DU FW Update Err Please Turn Pwr OFF	An error occurred during the DU firmware update. <ul style="list-style-type: none"> • Turn off the power and restart the CU. (When the update cannot be performed for the 1st DU, or an error occurs during the update process and the update cannot be continued.)
21	Completed except serial numbers below. Please turn power OFF. XXXXXXXXXX XXXXXXXXXX (Displays a list of 8-digit serial numbers of DUs for which the update cannot be performed.)	Part of DU Failed Please Turn Pwr OFF	The DU firmware update has been completed but the update cannot be performed for some DUs. <ol style="list-style-type: none"> ① The serial numbers of DUs for which the update cannot be performed will be listed on the pop-up screen. Write them down. ② Turn off the power. ③ Disconnect the DUs with the serial numbers you wrote down. ④ Perform emergency update for the DUs you disconnected in step ③. For details on how to perform the emergency update, contact our sales representative.
22	Data acquisition error.	Data Acquisition Err	Failed to acquire data through operation via Web Remote or the CU display. <ul style="list-style-type: none"> • Perform the operation again and check whether the same error occurs.

	Web Remote	CU display (LED indicators)	State/remedies
23	Unable to Set	Unable to Set	(1) Unusable characters are contained in the string of letters you have entered. • Delete unusable characters. (2) The change cannot be applied because the entered values are out of the permitted range or the change is not allowed. • Enter values within the permitted range. • Check that the unit is in a state where changes are allowed and then perform the operation again and check whether the same error occurs.
		Can't.ReducePriority	(3) The setting of [Number of Open Mics] (<i>NOM</i>) cannot be changed due to the current number of priority DUs. • Set a different number for [Number of Open Mics] (<i>NOM</i>) or change the number of priority DUs.
24	Unable to set. Change all DU talk modes to OFF.	Can't.Chg All DU OFF	(4) Since recording, recording pause, or file reading process is under way, any recording-related settings cannot be configured. • Stop recording and then perform the operation again. (5) Since not all DUs are in Talk OFF state, you cannot change the settings. Set all connected DUs to Talk OFF state.
25	Unable to control.	Unable to Ctrl	(1) Since recording, recording pause, or file reading process is under way, the operation cannot be performed. (2) Due to other reasons, the operation cannot be performed. (Operations except changing settings cannot be performed.) • Stop recording and then perform the operation again.
26	Number of priority units exceeds maximum. Reduced priority channels.	-	The number of DUs which are set as priority DUs exceeded the limit due to CU Link. Decrease the number of priority DUs. (Deactivate the priority setting for some DUs.) • Check the priority DUs and change the setting as necessary.
27	Unable to set. Number of priority channels exceeds maximum.	-	The maximum number of DUs that can be designated as priority DU is 1 unit less than the specified value for [Number of Open Mics] (<i>NOM</i>). No more DUs can be designated as a priority DU. • Change the setting value for the <i>NOM</i> or DU priority setting.
28	Recording Failed	-	A recording function error occurs such as a recording error not due to recording operations via Web Remote. • Check that no error occurs during recording on the CU. If an error occurs, solve the problem according to the error.
29	-	Boot Error XXX	An error occurred while booting the CU. (XXX indicate an error code.) • Restart the CU and check whether the same error occurs. If the same error occurs again, the CU requires repair.
30	-	Chg to FreeTalk Mode	Since a communication error occurred with the control device, the conference mode will be switched to Free Talk Mode where you do not need the control device. • Check that there is no network connection problem.
31	-	CU ForcibleFW Update	Emergency update executes for the CU. • Follow the message displayed and do not turn off during the update.
32	-	DU ForcibleFW Update	Emergency update executes for the DU. • Follow the message displayed and do not turn off during the update.
33	-	Connect USB Device with FW Update File	Emergency update executes (for the CU or the DU). • Insert a USB control device (mass storage device) where the firmware is stored to the CU.

Specifications

ATUC-50CU specifications

General specifications

I/O Connectors	Inputs	Mic/Line×2, AUX (ST)×1, INTERPRETATION RETURN×2	
	Outputs	BAL.×4, UNBAL.×1	
	LINK/CHAIN	DU A/B terminals, CU A/B terminals (DU C/D terminals)	
Recording(*1)	Via USB storage device	1/2/3/4 track (WAV) (BWF standard) 1/2 track (MP3) (Original format)	
	MP3 bit rate	64kbps/128kbps/192kbps/256kbps/320kbps	
Playback(*1)	WAV	Data length	16bit, 24bit
		Sampling frequency	48kHz
	MP3(*2)	Bit rate	32-320kbps
		Sampling frequency	48kHz
	Maximum file size	2GB	
	Maximum number of files	30files	
Signal delays		MIC Input to Output: 1ms DU to CU: 1.2ms	
Frequency response		+1.0, -2.0dB 20Hz - 20kHz, refer to +4dBu output @1kHz.	
Dynamic range		110dB A-Weighted	
Signal to noise		90dB A-Weighted	
Headroom		20dB	
Equivalent input noise	Mic/Line 1-2	Less than -126dBu Rs=150ohm	
Residual noise		Less than -86dBu A-Weighted	
Total harmonic distortion		Less than 0.03% 1kHz unity	
Crosstalk @1kHz		Less than -80dB	
OLED display		20 × 2 Character type, Color: Yellow	
Phantom power		DC+48V	
Power requirement		AC 100V-240V 50/60Hz	
Power consumption		20W-175W (max.), Connecting 50 ATUC-50DUs is equivalent to 2.55A.	
Operation guaranteed temperature range		0-40°C	
Operation guaranteed humidity range		25-85%	
External dimensions (W × D × H)		482.6mm × 331.6mm × 44mm	
Net Weight		3.4kg	
Finish	Front panel	Black	
	Top & Rear	Black	
Included Accessories		AC power cord, Quick Setup Guide ×2, Euroblock connectors ×9, Warranty	

*1 Supported file systems: FAT16/FAT32

*2 Supported format: MPEG-1 Audio Layer-3.

Input/output specifications

Analog input specifications

Input Terminals	Gain	Load Impedance	Input Level			Connector	Balanced/ Unbalanced
			Minimum	Unity	Maximum		
MIC/LINE Input 1-2	Mic 15-59dB	5k ohm	-60dBu	-40dBu	-16dBu	Euroblock	Balanced
	Line 15-59dB	20k ohm	-40dBu	+4dBu*/ 0dBu	+24dBu*/ +20dBu	Euroblock	Balanced
AUX Input LR (Mono x2)	-	10k ohm	-	0dBV*/ -10dBV/ -20dBV	+20dBV*/ +10dBV/ 0dBV	RCA Pin	Unbalanced
INTERPRETATION RETURN 1-2	-	20k ohm	-	+4dBu*/ 0dBu	+24dBu*/ +20dBu	Euroblock	Balanced

* Default setting

Analog output specifications

Output Terminals	Load Impedance	Output Level			Connector	Balanced/ Unbalanced
		Minimum	Unity	Maximum		
BAL. (Balanced) Output 1-4	150ohm	-	+4dBu	+24dBu	RCA Pin	Balanced
UNBAL. (Unbalanced) Output 1	300ohm	-	0dBV	+20dBV	Euroblock	Unbalanced

Digital input/output specifications

Terminals	Format	Data length/Sampling Frequency	Audio	Connector
USB	USB	24bit/48kHz	Playback: MP3 or WAV/Record: MP3 or WAV	USB (A type)
DU CHAIN A/B (C/D)	Original format	24bit/48kHz	Floor, Return, Interpretation language, Active Mic	RJ-45
CU LINK A/B	Original format	24bit/48kHz	Floor, Return, Interpretation language, Active Mic	RJ-45

Control I/O specifications

Terminals	Format	Level	Connector
NETWORK	IEEE802.3	10BASE-T/100BASE-TX	RJ-45

ATUC-50DU specifications

General specifications

I/O connectors	Inputs	Microphone jack×1
	Outputs	Headphone jack×1
	CHAIN	DU/CU connection terminals
Sampling frequency	24bit/48kHz	
Frequency response	+1.0, -2.0dB 20Hz - 20kHz, refer to +4dBu output @1kHz.	
Dynamic range	107dB A-Weighted	
Signal to noise	87dB A-Weighted	
Headroom	20dB	
Equivalent input noise	Less than -121dBu Rs=150ohm	
Total harmonic distortion	Less than 0.07% 1kHz unity	
Phantom power	DC+24V	
Power requirement	DC+48V	
Power consumption	2.2W	
Operation guaranteed temperature range	0-40°C	
Operation guaranteed humidity range	25-85%	
External dimensions (W × D × H)	135mm × 148.3mm × 84.2mm	
Net Weight	570g (900g including the optional bottom weight)	
Finish	Top panel	Gun metal
	Enclosure	Black
Included Accessories	Quick Setup Guide, Warranty	

Input/output specifications

Analog input specifications

Input Terminals	Gain	Load Impedance	Input Level			Connector	Balanced/ Unbalanced
			Minimum	Nominal	Maximum		
MIC Input	7-47dB	5k ohm	-60dBu	-40dBu	-20dBu	XLR female	Balanced

Analog output specifications

Output Terminals	Load Impedance	Output Level			Connector
		Minimum	Nominal	Maximum	
Headphones	32ohm	-	1.5mW	15mW	φ3.5mm Stereo
Speaker	8ohm	-	50mW	100mW	-

Digital input/output specifications

Terminals	Format	Data length/Sampling Frequency	Audio	Connector
DU CHAIN A/B	Original format	24bit/48kHz	Floor, Return, Interpretation language, Active Mic	RJ-45

Control I/O specifications

Terminals	Format	Level	Connector
Option port	UART	+5V, TX, RX, GND	RJ-11

ATUC-M specifications

	ATUC-M43H	ATUC-M58H
Type	Back electret type	
Directional characteristics	Hyper-cardioid	
Frequency characteristics	100-15,000Hz	
Sensitivity (0dB=1V/1Pa, 1kHz)	-40dB	
Maximum input sound pressure level (1kHz, THD1%)	134dB S.P.L.	
Signal-to-Noise ratio (1kHz, 1Pa)	64dB or more	
Output impedance	250ohms balanced	
Finish	Mat black baking paint finish	
External dimensions	18.9mm diameter×430mm	18.9mm diameter×580mm
Weight	Approx. 82g	Approx. 92g

